

NeoGCP i7 PLUS+

User's Guide

(Rev. F)



CAUTION

1. It is recommended to use RPM measurement method as MPU to prevent start motor damage when using Doosan engine.
2. If RPM measurement method is frequency, oil pressure switch is set to not use, and voltage is not generated at engine CRANK-ON, the start motor may be damaged.

■ MPU Method Setup

Menu	Setup
TEETH(FACTOR)	1. Select [SYSTEM] then [ENTER] on Menu screen. 2. Press [▼] 2 times, [▶] 2 times, select [TEETH(FACTOR)], then press [ENTER]. 3. Input Teeth number, then press [ENTER].
RUN-STATE OP-SWITCH Use / Not use	1. Select [CONTROL] then [ENTER] on Menu screen. 2. Press [▼] 3 times, [▶] 2 times, select [OIL PRESS SENSOR] then [ENTER]. 3. Select [Use] then press [ENTER].
RUN-STATE OP-GAUGE	1. Select [CONTROL] then [ENTER] on Menu screen. 2. Press [▼] 3 times, [▶] 1 time, select [RUN-STATE OP-GAUGE] then setup oil pressure.

※ 6.5 Refer to Crank ON/OFF

■ Doosan Engine Gear Teeth

Gear Teeth	Doosan Engine Model
129	DB33, PO34TI, DB58
140	D1146, D1146T
146	PO86TI
152	P126TI-3, P126TI, P126TI-II
160	P158LE-III, P158LE, P158LE-1, P158LE-2, P180LE-II, P158LE, P222LE-1, P222LE, P222LE-II, P222FE-II

※ Information above written in request of Doosan Commercial Engine(DSCE).

Start motor ON/OFF record stored in ALARM HISTORY.

If start motor is damaged due to ignoring above caution, free A/S from DSCE will NOT be possible even within warranty period.

- This manual can be applied to NeoGCP i7 PLUS+ Ver. 5.18 and up.
- Contact us for old version manuals.

Firmware Version	Application Manual Version	Changes
5.09a	Rev. A	<ul style="list-style-type: none"> - Manual for NeoGCP i7 PLUS+ - Added ECU alarm - Added ECU OFF function in FIAT engine standby status
5.10	Rev. B	<ul style="list-style-type: none"> - Added ECU related Modbus address (69~79)
5.13	Rev. C	<ul style="list-style-type: none"> - In the [ECU TYPE] menu, changed the name of the Baudouin engine to the CPU name.
5.14c	Rev. D	<ul style="list-style-type: none"> - Added WISE10B solenoid off (S-OFF) in Baudouin engine
5.16	Rev. E	<ul style="list-style-type: none"> - Added Volvo engine EDC4 and Rolls-Royce engine ECU8,9
5.18~	Rev. F	<ul style="list-style-type: none"> - CRANK ON CHECK TIME is fixed at 5 sec -> added settings - OVR(INSTANT) is fixed at 130% -> added settings - SVR DELAY renamed(SVR CHECK TIME) and path moved(CONTROL -> PRPOTECTION)

Table of Contents

1. Introduction.....	10
1.1. NeoGCP i7 PLUS+	10
1.2. Special Features.....	10
1.3. Product Image	10
1.4. Specification.....	10
2. Button usage and LED Lighting Status.....	11
2.1. Button usage.....	11
2.2. LED Lighting Status	11
3. LCD Display Status	12
3.1. Start Screen	12
3.2. Main Screen	12
3.2.1. 1 st Line	12
3.2.2. 3 rd Line.....	13
3.2.3. 4 th Line.....	13
3.2.4. 5 th Line.....	13
3.3. Alarm Screen.....	14
3.3.1. Alarm check	14
3.3.2. Alarm release.....	14
3.4. Menu Select Screen.....	14
3.5. Menu Setting Screen	14
4. NeoGCP i7 PLUS+ Cable Specification and Size	15
4.1. NeoGCP i7 PLUS+ Cable Specification	15
4.2. Mounting Hole Size of NeoGCP i7 PLUS+.....	15
5. NeoGCP i7 PLUS+ Input and Output Port.....	16
5.1. Number [1], Number [2] Vdc \pm	16
5.2. Number [3] ~ Number [5] MAIN R, S, T	17
5.3. Number [6] ~ Number [9] GEN PT U, V, W, N	18
5.4. Number [10], Number [11] MPU \pm	18

5.5. Number [12] ~ Number [14] RS485 ±	18
5.6. Number [15] ~ Number [24] DI-CONFIG.....	19
5.7. Number [25] ~ Number [40] DO-CONFIG	19
5.8. Number [43] ~ Number [48] Sensor Input.....	19
5.9. Number [49], Number [50] GEN ZCT K, L.....	20
5.10. Number [51] ~ Number [56] GEN CT U+,U-, V+,V-, W+,W-	20
6. Operation Sequence	21
6.1. Control Function According to Operation Mode.....	21
6.2. Operation Order	21
6.3. Ready	21
6.4. PRE-CRANK.....	22
6.5. CRANK ON/OFF	22
6.6. IDLE RUNNING.....	23
6.7. BUILD-UP.....	23
6.8. RUNNING.....	23
6.9. COOLDOWN.....	23
6.10. STOP.....	24
6.11. MANUAL.....	24
6.12. AUTO	24
6.13. FIRE.....	25
6.14. SCHEDULED-RUN	25
7. SYSTEM	27
7.1. POWER (P)	27
7.2. FREQUENCY (F)	27
7.3. VOLTAGE (V)	28
7.4. CURRENT (I)	28
7.5. GR CURRENT (GRI)	28
7.6. GEN WIRING (WIRE)	28
7.7. EXT-MODULE (EX)	28

7.8. ECU TYPE (ECU).....	29
7.8.1. When [EDC7C1 OFF] is set:	29
7.9. PT RATIO (PT)	30
7.10. CT RATIO (CT)	30
7.11. GR CT RATIO (ZCT)	30
7.12. RPM (RPM).....	30
7.13. GOVERNOR TYPE (GOV).....	30
7.14. TEETH(FACTOR) (TEETH)	31
7.15. BREAKER TYPE (TYPE)	31
7.15.1. ACB CLOSE DELAY (CLOSE)	31
7.15.2. ACB OPEN DELAY (OPEN)	31
7.15.3. START FAIL TRIP SET (TRIP)	31
7.16. BREAKER AUX CHECK (AUX)	31
7.17. BUTTON BEEP (BEEP)	31
7.18. ALARM HORN TIME (HORN)	32
7.19. BACK-LIGHT TIME (LIGHT)	32
7.20. DATE SETUP (DATE)	32
7.21. TIME SETUP (TIME).....	32
7.22. TIME COMPENSATION (CLOCK)	32
7.23. PASSWORD (PASSWORD)	32
8. SENSOR-SET	33
8.1. Sensor Use / Not use	33
8.2. RTD Sensor Resistance Value and Output setup	33
8.3. Fuel Level Gain and Offset	33
8.4. When Using EP20	33
9. DI-CONFIG	35
9.1. USER FAULT	36
9.2. USER FAULT (RUN)	36
9.3. USER FAULT (STOP)	36
9.4. EM'CY STOP S/W	36

9.5. COOLANT TEMP S/W	37
9.6. OIL PRESS S/W	37
9.7. COOLANT LEVEL S/W	37
9.8. NO CHARGING S/W	37
9.9. FAIL TO START	37
9.10. FAIL TO STOP	38
9.11. BUILD-UP EXPIRE.....	38
9.12. OVER SPEED.....	38
9.13. OCGR	38
9.14. BREAKER AUX.....	38
9.15. UVR SIGNAL.....	39
9.16. FIRE-RUN	39
9.17. BLOCK.....	39
9.18. MANUAL.....	39
9.19. AUTO	39
9.20. GEN START.....	40
9.21. GEN STOP	40
9.22. BREAKER CLOSE.....	40
9.23. BREAKER OPEN	40
9.24. ALARM RESET	41
9.25. IDLE RUN	41
9.26. GEN VOLTAGE CHANGE	41
9.27. BUZZER STOP.....	41
9.28. USER TIMER INPUT	41
9.29. OIL PRESS S/W LH	42
9.30. OIL PRESS S/W RH.....	42
9.31. COOLANT S/W LH	42
9.32. COOLANT S/W RH	42
9.33. OIL TEMP S/W	42

10. DO-CONFIG	43
10.1. C_PRE-CRANK	44
10.2. C_CRANK	44
10.3. C_GOVERNOR	45
10.4. C_BREAKER CLOSE	45
10.5. C_BREAKER OPEN	45
10.6. C_ALARM BUZZER	46
10.7. C_ALARM RESET	46
10.8. C_IDLE SPEED	46
10.9. C_RATED SPEED	46
10.10. C_AIR HEATER	47
10.11. C_USER TIMER	47
10.12. S_MAINS ON	47
10.13. S_MAINS OFF	47
10.14. S_GEN START	48
10.15. S_GEN RUNNING	48
10.16. S_BLOCK MODE, S_MANUAL MODE, S_AUTO MODE, S_FIRE-RUN	48
10.17. S_ALL ALARM, S_WARNING, S_HEAVY FAULT, S_TRIP FAULT, S_STOP FAULT,	48
S_SHUTDOWN FAULT	48
10.18. S_FUEL LEVEL	48
10.19. Alarm Status	48
10.20. Alarm Contacts1~10	49
11. CONTROL	49
12. PROTECTION	50
13. SERIAL COMM	53
14. GAIN-SET	54
15. PROTECTION TEST	55
16. HISTORY	55
17. Fault Items	56

17.1. Generator Related Fault Items	56
17.2. Engine Related Fault Items	57
17.3. Sensor Related Fault Items	58
17.4. Digital Input Related Fault.....	59
17.5. EP20 Related Alarm	59
18. Comm Protocol- MODBUS	62
18.1. MODBUS PROTOCOL.....	62
18.1.1. REQUEST (04h)	62
18.1.2. CONTROL (05h)	67
18.1.3. Communication example.....	67
18.2. GIMAC-II Plus PROTOCOL.....	68
18.2.1. REQUEST (04h)	68
18.2.2. CONTROL (05h)	69
19. Inverse Characteristics Curve	70

1. Introduction

1.1. NeoGCP i7 PLUS+

- Neo Generator Control Panel i7 PLUS+ (NeoGCP i7 PLUS+) is a digital type controller that uses microprocessor for single operating generators.

1.2. Special Features

- Easy and simple to set generator with 192 × 64 graphic LCD display.
- Built-in OVR, UVR, OCR, OCGR functions.
- Fast, accurate voltage and current measurement with a tolerance of 1% possible.
- [BLOCK], [MANUAL], [AUTO], [FIRE-RUN] operation possible, REAL-TIME function also lets [SCHEDULED-RUN] possible.
- Engine and fuselage protection operation in 7 levels.
- Save and view up to 30 faults.
- Built-in RS485 Comm port, supports Modbus Protocol 04h, 05h.
- 10 Digital Input, 8 Digital Output setup possible.

1.3. Product Image



< NeoGCP i7 PLUS+ front image >

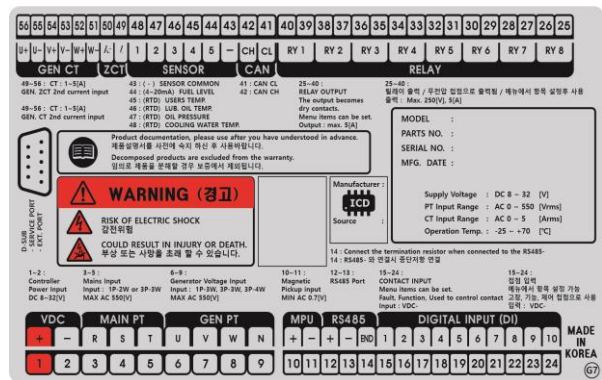

< NeoGCP i7 PLUS+ back image >

1.4. Specification

Size (mm)	240(L) × 178(W) × 53.5(H)	Operating Temperature	-20 ~ 70 °C
Weight	Approx 862 g	CT Input range	0 ~ 5 [A]
Controller power	8 ~ 32 Vdc	Generator power	Max AC 550 [Vrms]
Max power	4.8 W	Mains Sensing Method	Single-phase, 3phase, UVR Contact

2. Button usage and LED Lighting Status

2.1. Button usage

- Adjustment and setup of various operation information possible with buttons on the front.

ITEM	DESCRIPTION	
DIRECTION BUTTON	- Use to select generator information on Main screen. - Use to move Menu on Menu screen. - Use to move digits or change information on Menu screen.	
MODE	- Use to switch to [BLOCK], [MANUAL], [AUTO] mode.	
MENU	- Use to switch from Main screen to Menu screen.	
ENTER	- Use to select menu from Menu screen. - Use to input generator information on Menu screen.	
ESC	- Use to switch from Menu screen to Main screen. - Use to cancel changes of generator information on Menu screen. - Use to switch from Alarm check screen to Main screen without release of Alarm.	
LAMP TEST	- Use to check LED on Main screen.	
ALARM	- Use to switch to Alarm check screen when Alarm occurs. - Use to check Alarms in a sequential order when many Alarms occur.	
RESET	- Use to release Alarm	
CLOSE	- Use to close breaker in [MANUAL] mode.	
OPEN	- Use to open breaker in [MANUAL] mode.	
START	- Use to start generator in [MANUAL] mode.	
STOP	- Use to stop generator in [MANUAL] mode.	

2.2. LED Lighting Status

- LED indicates status of various operation and faults, whether breaker is open or closed.

ITEM	COLOR	DESCRIPTION
BLOCK	Yellow	Lit in [BLOCK] mode
MANUAL	Yellow	Lit in [MANUAL] mode
AUTO	Yellow	Lit in [AUTO] mode
GRID ON	Red	Lit in Mains On, off in Mains Off
ALARM	Red	Lit in Alarm condition, off when Alarm is released
CLOSE	Red	Lit in [BREAKER CLOSE], Off in [BREAKER OPEN]
OPEN	Green	Lit in [BREAKER OPEN], Off in [BREAKER CLOSE]
START	Yellow	Off in [STOP]

3. LCD Display Status

3.1. Start Screen

- When power is on, start screen will show product number and program version.



〈 Start screen 〉

3.2. Main Screen

- When program booting is completed from Start screen, it will switch to Main screen.
- Main screen displays main information of Gen-set.
- Main screen displays 4 lines which are as shown below.

Seq	Description
1 st Line	Operation Mode, Sequence Status, Sequence Timer
2 nd & 3 rd Line	Information on screen are changeable with [◀], [▶] buttons - Active power(kW), Gen-set voltage[V], Gen-set current[A], Power factor - Active power(kW, %), Gen-set voltage[V], Gen-set current[A]
4 th Line	Information on screen changeable with [◀], [▶] buttons - Current date and time - Mains voltage[V] - Gen-set voltage[V] - Gen-set phase voltage[V] - Gen-set current[A] - Ground current[A] - Apparent power[kVA], Reactive power[kvar], Power factor - Coolant temp[°C], Oil press[bar] - Oil temp[°C], User temp[°C], Fuel level [%] - Running hour[h] - Integrating wattmeter[kWh]
5 th Line	DI-CONFIG 01~10, DO-CONFIG 1~8, BUS or UVR signal timer (BUS or UVR signal timer will only output in [AUTO] mode)

3.2.1. 1st Line

- 1st line of Main screen displays Operation Status, Sequence Status, and Sequence Timer.

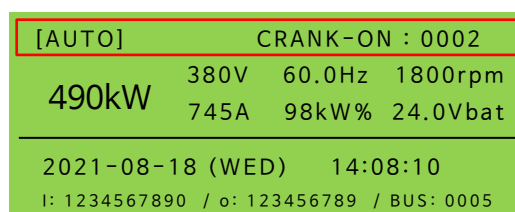

〈 Operation status, Sequence status, and Sequence timer 〉

3.2.2. 3rd Line

- Information on 2nd line changeable with [▶], [◀] buttons on Main screen.

[AUTO]	CRANK-ON : 0002		
490kW	380V	60.0Hz	1800rpm
	745A	98kW%	24.0Vbat
2021-08-18 (WED) 14:08:10			
I: 1234567890 / o: 123456789 / BUS: 0005			

< Active power(kW%) etc. >

[AUTO]	CRANK-ON : 0002		
490kW	380V	60.0Hz	1800rpm
	745A	1.00PF	24.0Vbat
2021-08-18 (WED) 14:08:10			
I: 1234567890 / o: 123456789 / BUS: 0005			

< Power factor etc. >

3.2.3. 4th Line

- Information on 4th line changeable with [▲], [▼] buttons on Main screen.

2021-08-18 (WED)	14:08:10
------------------	----------

< Current date and time >

GEN VOLT. L-L:	380/ 380/ 380V
----------------	----------------

< Gen-set voltage[V] >

GEN CURRENT:	745/ 745/ 745A
--------------	----------------

< Gen-set current[A] >

kVA:	0 /kvar:	0 /P.F:	1.00
------	----------	---------	------

< Ap. power[kVA], Re. power[kvar], PF >

O.T:	***°C /U.T:	***°C /F.L:	***%
------	-------------	-------------	------

< Oil temp[°C], User temp[°C], Fuel level [%] >

kWh:	0.00
------	------

< Integrating wattmeter[kWh] >

MAIN VOLT. L-L:	380/ 380V
-----------------	-----------

< Mains voltage[V] >

GEN VOLT. L-N:	220/ 220/ 220V
----------------	----------------

< Gen-set phase voltage[V] >

GR CURRENT:	0A
-------------	----

< Ground current[A] >

C.T:	***°C /O.P:	***bar
------	-------------	--------

< Coolant temp[°C], Oil press[bar] >

RUNNING HOUR:	0.00
---------------	------

< Running hour[h] >

3.2.4. 5th Line

- DI-CONFIG 01~10, DO-CONFIG 1~8, BUS or UVR SIGNAL timer displayed.

- BUS or UVR SIGNAL will only output in [AUTO] mode.

[AUTO]	CRANK-ON : 0002		
490kW	380V	60.0Hz	1800rpm
	745A	98kW%	24.0Vbat
2021-08-18 (WED) 14:08:10			
I: 1234567890 / o: 123456789 / BUS: 0005			

< DI-CONFIG, DO-CONFIG, BUS or UVR signal timer >

3.3. Alarm Screen

3.3.1. Alarm check

- In case of alarm condition, screen will automatically switch to Alarm screen.
- Number on the right of [ALARM MESSAGE] indicates number of times alarm has occurred.
- When multiple alarm occurs, press [ALARM] button to check contents of alarm in a sequence.

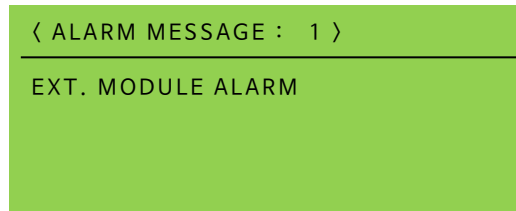

< Alarm screen >

3.3.2. Alarm release

- After alarm condition is resolved, press [RESET] button to release alarm.
- If [ALARM] is pressed without solving alarm condition, Main screen will be displayed.

3.4. Menu Select Screen

- Press [MENU] button on main screen and it will switch to Menu select screen.
- Press [▲], [▼] buttons on main screen to select desired item then press [ENTER] button to move to Menu select screen.

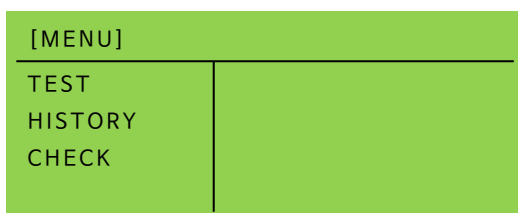
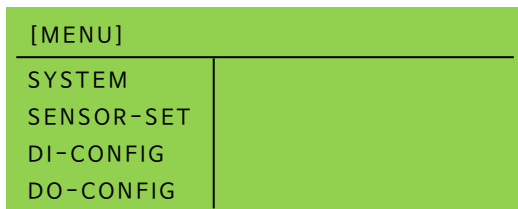

< Menu select screen >

3.5. Menu Setting Screen

- Bottom line of Menu setting screen shows english abbreviation of the menus that can be selected on the screen.
- When a menu is selected, an exclamation mark will be shown next to the English abbreviation.

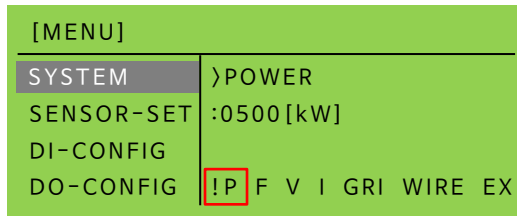

〈 Menu setting screen 〉

- Press [◀], [▶] and [▲], [▼] buttons on Menu screen to select desired item and press [ENTER] button.
- Then press [▲], [▼] buttons to modify main information of Gen-set.

4. NeoGCP i7 PLUS+ Cable Specification and Size

4.1. NeoGCP i7 PLUS+ Cable Specification

- All input and output of NeoGCP i7 PLUS+ implemented by pluggable terminal block.



〈 Pluggable Terminal Block 〉

- Cable specification as shown below, separation of low-current cables and high-current cables recommended to prevent noise.

Cable Thickness	0.34 ~ 2.5 mm ²
Solid Cable (AWG)	12 ~ 24
Stranded Cable (AWG)	12 ~ 24
Screw Size	M3
Pin Terminal Length	6 ~ 7 mm

4.2. Mounting Hole Size of NeoGCP i7 PLUS+

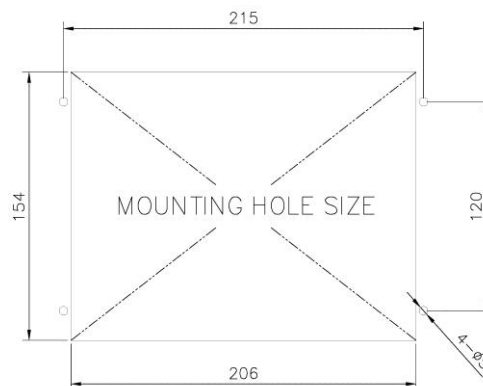

5. NeoGCP i7 PLUS+ Input and Output Port

No.	Item	Description
1	VDC+	Controller Power Input 8~32 [Vdc]
2	VDC-	
3	MAIN R	Mains Voltage input Max 550 [Vac] R,S,T or R,S
4	MAIN S	
5	MAIN T	
6	GEN PT U	Gen-set Voltage Input Max AC 550 [V] 1P-2W, 1P-3W, 3P-3W, 3P-4W
7	GEN PT V	
8	GEN PT W	
9	GEN PT N	
10	MPU+	Magnetic Pick-up Input Min 0.7 [Vac]
11	MPU-	
12	RS485+	RS485 Comm Port Input
13	RS485-	
14	RS485 END	Terminating resistance of 120 [Ω] when connected to RS485-
15	DI 1 SET	Digital Input (Vdc-)
16	DI 2 SET	
17	DI 3 SET	
18	DI 4 SET	
19	DI 5 SET	
20	DI 6 SET	
21	DI 7 SET	
22	DI 8 SET	
23	DI 9 SET	
24	DI 10 SET	

No.	Item	Description
56	GEN CT U+	Gen-set Current Input (CT 2 nd) 0.01~10 [A], Max 10 [A], Peak 1 [s] 1P-3W : U(56/55), V(54/53), W(52/51) 1P-2W : U(56/55)
55	GEN CT U-	
54	GEN CT V+	
53	GEN CT V-	
52	GEN CT W+	
51	GEN CT W-	
50	GEN ZCT K	Gen-set Ground Current Input (CT 2 nd) 0.01~10 [A], Max 10 [A], Peak 1 [s]
49	GEN ZCT L	
48	SENSOR 1	Coolant Temp Sensor Input (RTD)
47	SENSOR 2	Oil Press Sensor Input (RTD)
46	SENSOR 3	Oil Temp Sensor Input (RTD)
45	SENSOR 4	User Temp Sensor Input (RTD)
44	SENSOR 5	Fuel Level Sensor Input (4~20mA)
43	SENSOR COM-	Sensor Common (Vdc-)
42	CH	Not used
41	CL	
40	DO 1 SET	Digital Output Max 250 [Vac], 24 [Vdc], 5 [A]
39	DO 2 SET	
38	DO 3 SET	
37	DO 4 SET	
36	DO 5 SET	
35	DO 6 SET	
34	DO 7 SET	
33	DO 8 SET	
32	DO 9 SET	
31	DO 10 SET	
30	DO 11 SET	
29	DO 12 SET	
28	DO 13 SET	
27	DO 14 SET	
26	DO 15 SET	
25	DO 16 SET	

5.1. Number [1], Number [2] Vdc ±

- Number [1] and [2] ports supply power to 8~32 [Vdc].
- When power is supplied, there is a possibility of an inrush current depending on impedance of power supply.
- To prevent damage from inrush current, overcurrent protection device such as a fuse or breaker is recommended to be connected in series with power cable.

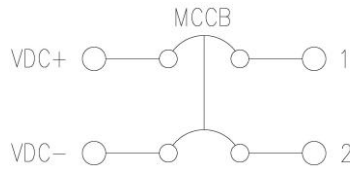

〈 Power supply overcurrent protection example 〉

5.2. Number [3] ~ Number [5] MAIN R, S, T

- Detect Mains voltage by Numbers [3] ~ [5] ports.
- Detect Mains voltage in [AUTO] mode and gen-set starts or stops after set delay time.
- Use [MENU]→[CONTROL]→[MAINS SENSING] only when set as [MAIN R-S-T] or [R-S Voltage], not to be used when set as [UVR SIGNAL].
- [UVR SIGNAL] can be used as corresponding contact after changing setup of contact to [UVR SIGNAL] in [MENU]→[DI-CONFIG].

Menus that are influenced	Set value	Description
[CONTROL] → [MAINS SENSING]	[MAIN R-S-T]	Numbers [3], [4], [5]
	[MAIN R-S]	Numbers [3], [4]
	[UVR SIGNAL]	User Set DI Port
[CONTROL] → [MAINS SENSING] → [AUTO-START DELAY]	0 ~ 7200 [s]	[AUTO] Run Delay Time
[CONTROL] → [MAINS SENSING] → [AUTO-START VOLTAGE]	0 ~ 6600 [Vac]	[AUTO] Run Voltage
[CONTROL] → [MAINS SENSING] → [AUTO-STOP DELAY]	0 ~ 7200 [s]	[AUTO] Stop Delay Time
[CONTROL] → [MAINS SENSING] → [AUTO-STOP VOLTAGE]	0 ~ 6600 [Vac]	[AUTO] Stop Voltage

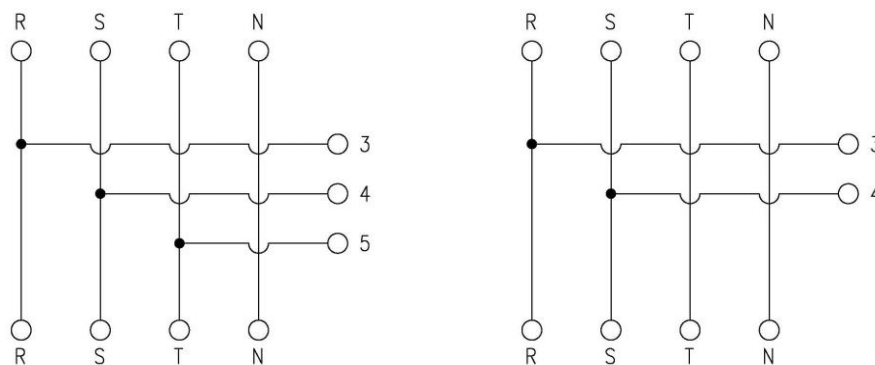

〈 Mains voltage detection wiring example 〉

5.3. Number [6] ~ Number [9] GEN PT U, V, W, N

- Detects generator voltage of Max AC 550[Vrms] by Numbers [6] ~ [9] ports.
- Wiring should be as follows.
 1P-2W : L1-6, N-7 / 1P-3W : L1-6, N-7, L2-8 / 3P-3W : U-6, V-7, W-8 / 3P-4W : U-6, V-7, W-8, N-9
- If generator voltage exceeds AC 550[Vrms], user should use PT(Potential Transformer) and 2nd Voltage should not exceed AC 550[Vrms].

Menus that are influenced	Set value	Description
[SYSTEM] → [VOLTAGE]	110 ~ 6600	PT 1 st voltage input
[SYSTEM] → [PT RATIO]	1 ~ 99.99	PT Ratio for user setup

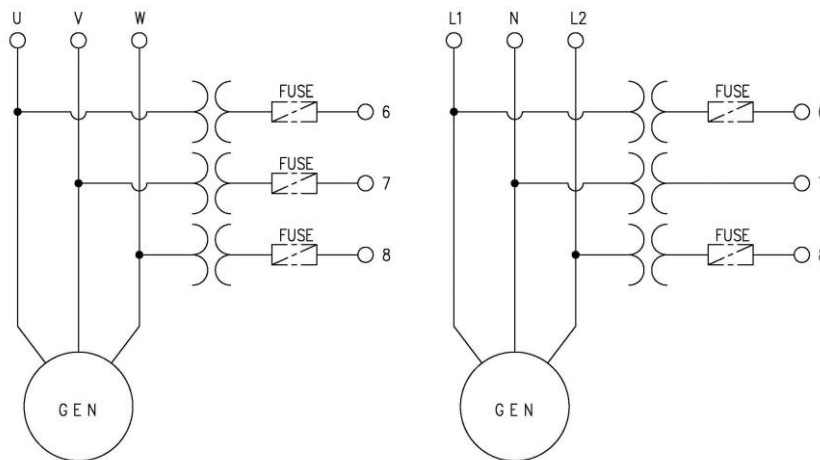

< GEN PT Wiring example >

5.4. Number [10], Number [11] MPU ±

- Detects magnetic pickup sensor input of Min 0.7[Vac] by numbers [10] and [11] ports.
- If [MENU] → [SYSTEM] → [ENGINE RPM] → [TEETH(FACTOR)] is set as 30, RPM measurement will be in Frequency and do not use MPU.

Menus that are influenced	Set Value	Description
[SYSTEM] → [ENGINE RPM] → [TEETH(FACTOR)]	31 ~ 250	RPM measurement in MPU
	30, 20(6pole)	RPM measurement in Voltage

5.5. Number [12] ~ Number [14] RS485 ±

- Sensing of RS485 ± by number [12] and [13] ports.
- Connect ports [13] and [14], then terminal resistance 120 [Ω] will be connected.

5.6. Number [15] ~ Number [24] DI-CONFIG

- When Vdc - is input through ports [15] - [24], corresponding signal will be as shown below.
- For details of DI, refer to [DI 09 SET].

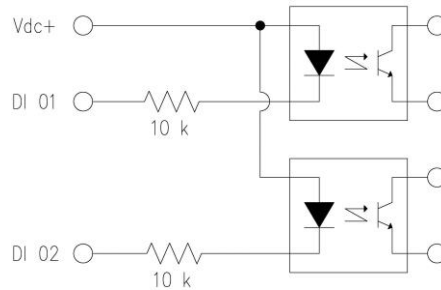

< DI Wiring Diagram >

5.7. Number [25] ~ Number [40] DO-CONFIG

- Output signal set by user will transmit through ports [25] ~ [40].
- Capacity of RELAY 1 ~ RELAY 8 is 250[Vac], 24[Vdc], MAX 5[A].
- When using external relay, please consider relay capacity.
- For details of DO, refer to [DO 10 Set].

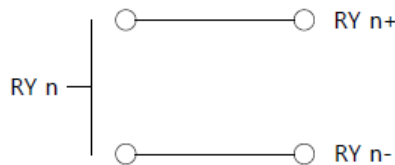

< DO Wiring Pattern Diagram >

5.8. Number [43] ~ Number [48] Sensor Input

- Common of sensors will be input by port [43].
- Fuel level sensor of 4~20 [mA] will be input by port [44].
- User temp sensor will be input by port [45].
- RTD type Oil sensor will be input by port [46].
- RTD type Oil press sensor will be input by port [47].
- RTD type Coolant temp sensor will be input by port [48].

5.9. Number [49], Number [50] GEN ZCT K, L

- Detects Ground Current by ports [47], [48].
- Measurable minimum current 0.01 [Arms], maximum current 10 [Arms], and peak time 1 [s].
- Change of setup needed according to type of ZCT (Video current transformer : Zero Current Transformer).

Menu	Set Value	Description
[SYSTEM] → [PT RATIO] → [GR CT RATIO]	User setup	Ground Current sensing

5.10. Number [51] ~ Number [56] GEN CT U+,U-, V+,V-, W+,W-

- Detects current by ports [51] ~ [56].
- Wiring should be as follows.
 - 1P-2W : U+(56),U-(55)
 - 1P-3W : U+(56), U-(55), V+(54), V-(53)
 - 3P-3W or 3P-4W : U+(56), U-(55), V+(54), V-(53), W+(52), W-(51)
- Measurable minimum current 0.01 [Arms], maximum current 10 [Arms], and peak time 1 [s].
- Change of setup needed according to the CT (Current Transformer) of user.

Menu	Set Value	Port used
[SYSTEM] → [PT RATIO] → [CT RATIO]	User setup	Gen-set current sensing

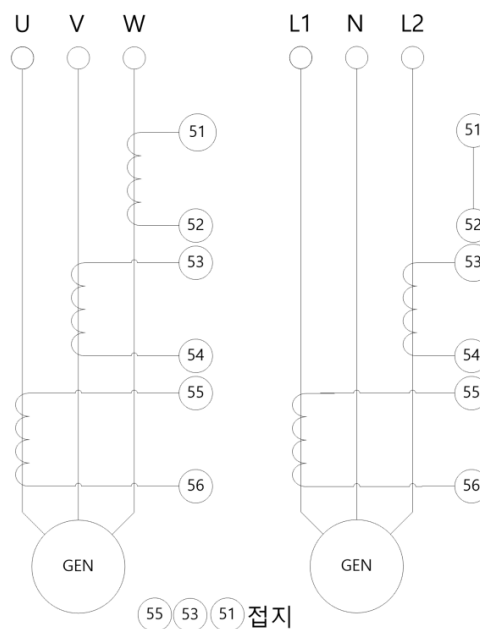

< CT Wiring Example >

6. Operation Sequence

6.1. Control Function According to Operation Mode.

Functions	BLOCK	MANUAL	AUTO	FIRE
LCD Screen	[BLOCK]	[MANUAL]	[AUTO]	[FIRE-RUN]
LED Indicator	BLOCK : ON MANUAL : OFF AUTO : OFF	BLOCK : OFF MANUAL : ON AUTO : OFF	BLOCK : OFF MANUAL : OFF AUTO : ON	BLOCK : OFF MANUAL : ON AUTO : ON
Mode Select	[MODE] Button	[MODE] Button	[MODE] Button	Arbitrary setup impossible
Select Mode	Non Applicable	Possible	Possible	Possible
Gen-Set Start	Impossible	[START] Button	Mains Off	Continuous Input
Gen-Set Stop	Non Applicable	[STOP] Button	Mains On	No Input
Protection	Partly Possible	Possible	Possible	Possible
ACB Control	Non Applicable	[CLOSE], [OPEN] Button	Auto	Auto
Cooldown	Non Applicable	Impossible	Possible	Possible
Change Parameter	Possible	Partly Possible	Partly Possible	Partly Possible
Fault History Delete	Possible	Impossible	Impossible	Impossible
MODBUS Comm	Possible	Possible	Possible	Possible

6.2. Operation Order

- Sequence of generator operation as shown below.

Order	Item	Description
1	[READY]	Ready to run
2	[PRE-CRANK]	When [PRE-CRANK TIME] is set, DO-CONFIG [C_PRE-CRANK] will output
3	[CRANK-ON]	Start
4	[CRANK-OFF]	In case of start failure, standby until next start
5	[IDLE RUN]	IDLE run
6	[BUILD-UP]	Voltage, Frequency, and RPM waiting time to fall within rated range
7	[RUNNING]	Nominal run status, Load run possible
8	[COOLDOWN]	Cool down
9	[STOP]	Stop

6.3. Ready

- In order to be in [READY] status to start Gen-set, following 3 conditions must meet.
- If following conditions do not meet, status will switch to [CHECK] mode and, [C_CRANK] will not output.
- If status is [CHECK] in [AUTO] mode, [F_FAIL TO STOP] Alarm situation will occur.

Conditions	Menus that are influenced	Description
RPM	-	Should be 0 [RPM]
Oil Press Sensor	[CONTROL] → [RUN-STATE OP-GAUGE]	[0] and up: lower than set value [0] : No check
Oil Press switch	[CONTROL] → [[RUN-STATE OP-SWITCH]	[USE] : Should be Oil Press Low [NOT USE] :No check

6.4. PRE-CRANK

- When Gen-set start signal is [READY], [C_PRE-CRANK] will output and then status will switch to [PRE-CRANK].
- If [PRE-CRANK TIME] reaches 0, status will switch to [CRANK-ON] after Gen-set start signal input.

Menus that are influenced	Setup	Description
[CONTROL] → [PRE-CRANK TIME]	0 ~ 60 [s]	[C_PRE-CRANK] will output during set time

6.5. CRANK ON/OFF

- [C_CRANK] will output to run Gen-set.
- If one of the conditions such as [RUN-STATE RPM], [RUN-STATE OP-GAUGE], [RUN-STATE OP-SWITCH] meet, status will switch to [IDLE RUNNING].
- If 3 conditions do not meet, status will switch to [STOP] in [MANUAL] mode and in [AUTO] or [FIRE] mode, Gen-set will start for a set number of times and then [FAIL TO START] alarm situation will occur.
- If [TEETH(FACTOR)] is 30, separate [CRANK-CHECK] time will countdown for set time after [CRANK-ON] and then will check Run-state.

Item	Menus that are influenced	Description
Run- State	[CONTROL] → [RUN-STATE RPM]	Should be higher than set value
	[CONTROL] → [RUN-STATE OP-GAUGE]	[0] and up: higher than set value [0] : No check
	[CONTROL] → [RUN-STATE OP-SWITCH]	[USE] : Should not be low oil pressure status [NOT USE] :No check
Crank Attempts	[CONTROL] → [CRANK-ON TIME]	[C_CRANK] output time
	[CONTROL] → [CRANK ON CHECK TIME]	Crank-on checking time during set time if [TEETH(FACTOR)] is 30
	[CONTROL] → [CRANK-OFF TIME]	Delay time until next crank
	[CONTROL] → [CRANK ATTEMPTS]	Number of cranking repeat in [AUTO] mode

6.6. IDLE RUNNING

- If [IDLE STATUS] is being input or [IDLE TIME] is set, status will switch to [IDLE RUNNING].
- If [IDLE STATUS] is not being input, or [IDLE TIME] is 0, status will switch to [BUILD-UP].
- [C_IDLE SPEED] will output even during [CRANK-ON], [CRANK-CHECK].

Menus that are influenced	Setup	Description
[DI-CONFIG] → [IDLE STATUS]	USE	[C_IDLE SPEED] during [IDLE STATUS]
[CONTROL] → [IDLE TIME]	0 ~ 60[s]	[IDLE RUNNING] until set time

6.7. BUILD-UP

- Check to see if RPM, Frequency and Voltage have reached the nominal range of user set value.
- If 3 conditions meet, status will switch to [RUNNING]
- If Gen-set check is not completed within [BUILD-UP TIME], [FAIL TO BUILD-UP] ALARM will output.

Menus that are influenced	Setup	Description
[CONTROL] → [BUILD-UP TIME]	5 ~ 600[s]	Build-up checking time during set time
[PROTECTION] → [OVER SPEED], [UNDER SPEED]	User setup	RPM check of user set range
[PROTECTION] → [OVER FREQUENCY], [UNDER FREQUENCY]	User setup	Frequency check of user set range
[PROTECTION] → [OVER VOLTAGE], [UNDER VOLTAGE]	User setup	Voltage check of user set range

6.8. RUNNING

- If breaker trip situation does not occur, breaker can open/close automatically or manually according to user set value.
- If Gen-set stop signal is input in [AUTO] and [MANUAL] mode, status will switch to [COOLDOWN].
- If stopped during [MANUAL] operation, engine will stop after Cool Down process. To stop immediately, press the [STOP] button twice.

6.9. COOLDOWN

- Operates in [AUTO] and [Manual] mode.
- No-load run during [COOLDOWN TIME] and then status will switch to [STOP].
- Press the stop button twice in [MANUAL] mode, it will stop immediately.
- [C_BREAKER OPEN] will output.
- If Gen-set start signal is input, status will switch to [RUNNING].

Menus that are influenced	Setup	Description
[CONTROL] → [COOLDOWN]	0 ~ 600 [s]	[COOLDOWN] during set time

6.10. STOP

- [STOP], then switch to [READY].
- Check of stop status when using [PROTECTION] → [FAIL TO STOP].
- If RPM, Oil press sensor, Oil press switch are not in stop status until [STOP-HOLD TIME] reaches 0, [F_FAIL TO STOP] Alarm will output.

Item	Menus that are influenced	Description
Stop Failure	[PROTECTION] → [FAIL TO STOP]	Setup Use/Not use
RPM	-	Should be 0 [RPM]
Oil Press Sensor	[CONTROL] → [RUN-STATE OP-GAUGE]	[0] and up: lower than set value [0] : No check
Oil Press Switch	[CONTROL] → [RUN-STATE OP-SWITCH]	[USE] : Should be Oil Press Low [NOT USE] : No check

6.11. MANUAL

- [START], [STOP], [BREAKER CLOSE], [BREAKER OPEN] can be controlled manually.
- [COOLDOWN TIME] will be applied. If the [STOP] button is pressed during Cool Down process, it stops immediately without cooling.
- [MANUAL] will be displayed on LCD and [MANUAL] LED will be lit.
- If Breaker type is ACB, running sequence is as shown below.

Order	Button	Description
1	[MODE]	Switch to [MANUAL] mode
2	[START]	Gen-set run
3	[BREAKER CLOSE]	Breaker Close → Load Run
4	[BREAKER OPEN]	Breaker Open → No-load Run
5	[STOP]	Gen-set Stop

6.12. AUTO

- Controls generator automatically, and [START], [STOP], [BREAKER CLOSE], [BREAKER OPEN] buttons will not activate.
- [AUTO] will be displayed on LCD and [AUTO] LED will be lit.
- If breaker type is ACB, refer to following example on the next page for general operation procedure.

6.13. FIRE

- When [FIRE-RUN] is implemented, status will switch to [FIRE] mode and operation status will be same as [AUTO] mode.
- [FIRE] will be displayed on LCD and [AUTO], [MANUAL] LED will be lit.
- If [FIRE-RUN] is not input or [EM'CY STOP] is input or Shutdown Alarm occurs, Gen-set will stop and status will switch to the mode setup before [FIRE].

Menus that are influenced	Setup	Description
[DI-CONFIG] → [EM'CY STOP]	User setup	[EM'CY STOP] input

6.14. SCHEDULED-RUN

- Will not activate if [SCHEDULED-RUN START] time is set after [SCHEDULED-RUN STOP] time, or if [SCHEDULED-RUN START] time is set same as [SCHEDULED-RUN STOP] time.
- Scheduled run only activates in [AUTO] mode.
- If Mains Off is input during scheduled-run, status will automatically switch to [AUTO] mode.

Menus that are influenced	Setup	Description
[CONTROL] → [SCHEDULED-RUN]	User setup	User setup related to scheduled-run

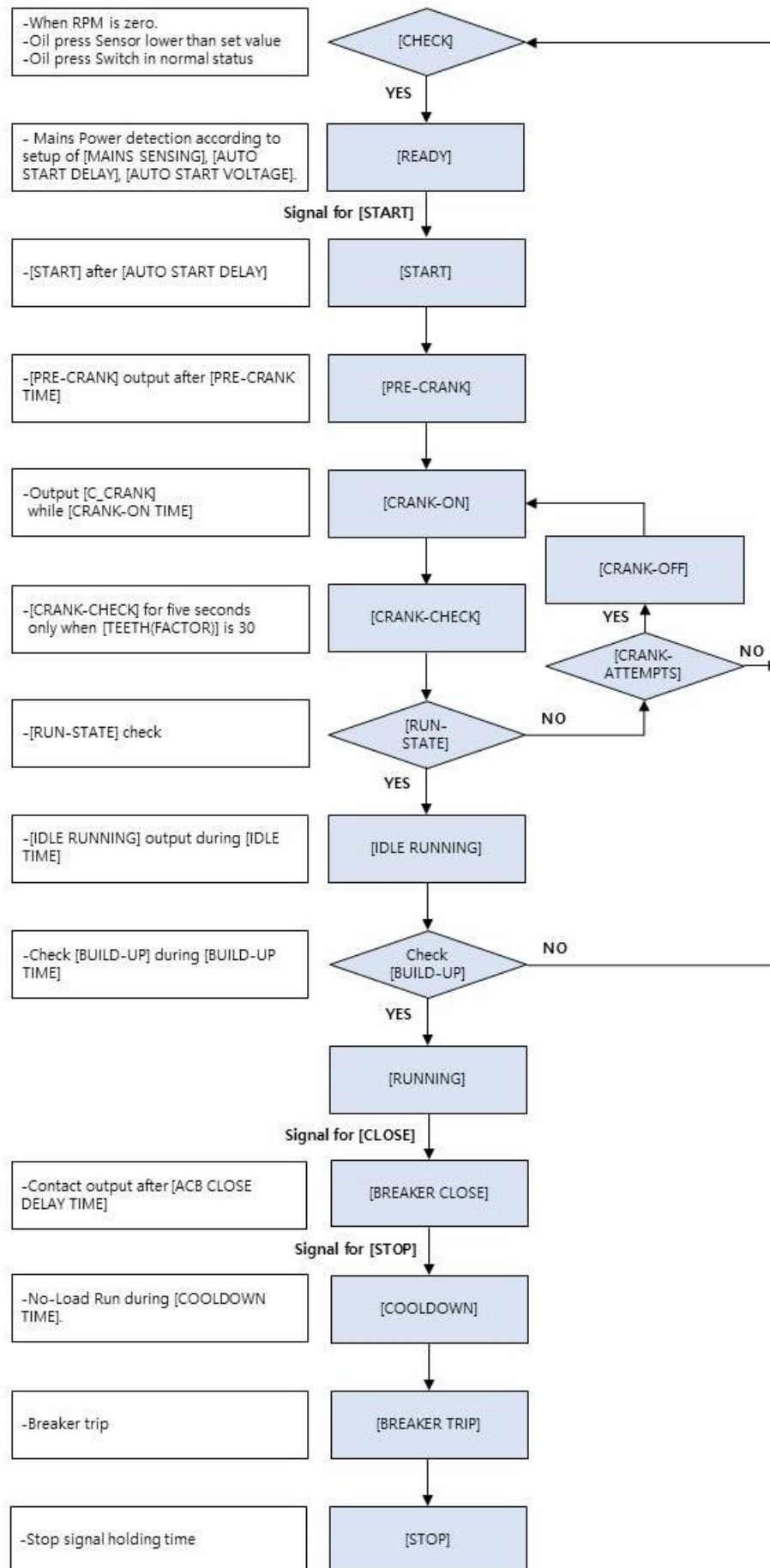

< [AUTO] Mode Sequence Setup Example >

7. SYSTEM

- Setup of basic information to run Gen-set.
- Setup possible in stop mode. (Some menus excluded)

Menu		Description	Setup
POWER	P	Input rated kW of GEN-SET	0 ~ 5000 [kW]
FREQUENCY	F	Input Rated Frequency of GEN-SET	40 ~ 60 [Hz]
VOLTAGE	V	Input Rated Voltage of GEN-SET	110 ~ 6600 [V]
CURRENT	I	Input Rated Current of GEN-SET	5 ~ 9999 [A]
GR CURRENT	GRI	Input Ground Current of GEN-SET	5 ~ 9999 [A]
GEN WIRING	WIRE	Select Generator Wiring Type	1P-2W / 1P-3W / 3PHASE
EXT-MODULE	EX	EXT-Module Use/ Not use	Not use / EM20 / EP20
ECU TYPE	ECU	Setup ECU Type	Refer to [7.8] ECU TYPE
PT RATIO	PT	Input PT Ratio	1.00 ~ 99.99
CT RATIO	CT	Input CT Ratio	5/1 ~ 9999/5
GR CT RATIO	ZCT	Input ZCT Ratio	5/1 ~ 9999/5
ENGINE RPM	RPM	Input RPM of GEN-SET	0 ~ 4000
GOVERNOR TYPE	GOV	Input Governor Type	Fuel / Stop
TEETH(FACTOR)	TEETH	Input Engine Gear Teeth	0 ~ 250
BREAKER TYPE	TYPE	Setup Breaker Type	MCCB / ACB / MC
BREAKER AUX CHECK	AUX	Setup Breaker Auxiliary contact	Use / Not use
ACB CLOSE DELAY	CLOSE	Close contact output after set time	0 ~ 60 [s]
ACB OPEN DELAY	OPEN	Open contact output after set time	0 ~ 60 [s]
BUTTON BEEP	BEEP	Setup Button Sound	Use / Not use
ALARM HORN TIME	HORN	Setup Alarm Sound Output Time	0 ~ 600 [s]
BACK-LIGHT TIME	LIGHT	Setup Back-light Holding Time	0 ~ 600 [s]
DATE SETUP	DATE	Setup Present Date	-
TIME SETUP	TIME	Setup Present Time	00:00 ~ 23:59
TIME COMPENSATION	CLOCK	Adjust Clock	-31 ~ +31
PASSWORD	PASS.	Password to enter the menu	0 ~ 9999 (Password released when 0)

7.1. POWER (P)

- Setup rated output of Gen-set.
- Setup : 0 ~ 5000 [kW]

7.2. FREQUENCY (F)

- Setup frequency of Gen-set.
- Setup : 40 ~ 60 [Hz]

7.3. VOLTAGE (V)

- Setup rated voltage(line voltage) of Gen-set.
- Setup : 110 ~ 6600 [V]

7.4. CURRENT (I)

- Setup rated current of Gen-set.
- Setup : 5 ~ 9999 [A]

Rated Current Formula
Rated Current [A] = Rated Output [kW] × 1000 ÷ {Rated Voltage [V] × 1.732 × Power Factor (cosθ)}

7.5. GR CURRENT (GRI)

- Setup ground current of Gen-set.
- Setup : 5 ~ 9999 [A]

7.6. GEN WIRING (WIRE)

- Select wiring type of Gen-set.
- Setup : 1P-2W, 1P-3W, 3PHASE
- Wiring differs according to wiring type of Generator.

7.7. EXT-MODULE (EX)

- Select use / not use of EXT-MODULE.
- Setup : Not use, EM20, EP20
- Purchase of additional I/O ports is possible for EXT-MODULE.
- When using Extension module(EM20, EP20), number of additional setup will increase.
- Refer to Extension module(EM20, EP20) manual for details.

Setup	Menus that are influenced	Description
Not use	[DI-CONFIG]	[DI 01 SET] ~ [DI 10 SET]
	[DO-CONFIG]	[DO 01 SET] ~ [DO 08 SET]
EM20	[DI-CONFIG]	[DI 01 SET] ~ [DI 18 SET]
	[DO-CONFIG]	[DO 01 SET] ~ [DO 16 SET]
EP20	[DI-CONFIG]	[DI 01 SET] ~ [DI 18 SET]
	[DO-CONFIG]	[DO 01 SET] ~ [DO 72 SET]
	[SENSOR-SET]	[Ext. Sensor 1 ~ 8] Use/ Not use [Ext. Sensor 1 ~ 8] Data
	[PROTECTION]	[Ext. Sensor 1 ~ 8] Alarm setup
	EP20-1~8	EXT-MODULE can be expanded up to 8

7.8. ECU TYPE (ECU)

- NeoGCP g7 model with built-in CAN communication is recommended.
- Select : Not use, EMSS6, EDC7C1, EDC17CV41, WISE15, WISE15(A/H), WISE10B, EMSS2, DN03, EDC7C1 OFF, WISE10B S-OFF, EDC4, ECU8,9
- Must use a separate CAN converter sold by our company when using ECU type.
- If NeoGCP g7 model is used, the built-in CAN function can be used without a separate converter.
- When using ECU TYPE, previous setup value will be adjusted to relevant ECU.
- If separate setup is needed, setup ECU TYPE first then change user setup.

Menus that will change when using EMSS6		After changes
[SENSOR-SET]	[COOLANT TEMP SENSOR]	Not use
	[OIL PRESS SENSOR]	Not use
	[OIL TEMP SENSOR]	Not use
	[USER TEMP SENSOR]	Not use
	[FUEL LEVEL SENSOR]	Not use
	[EXT-MODULE SENSOR 1~8]	Not use
[CONTROL]	[IDLE TIME]	5 [s]
	[CRANK OFF TIME]	15 [s]
	[CRANK ON TIME]	15 [s]
[PROTECTION]	[OIL PRESS LOW]	2.7 [bar]
	[COOLANT TEMP HIGH]	103 [°C]

Menus that will change when using EDC7C1		After changes
[SENSOR-SET]	[COOLANT TEMP SENSOR]	Not use
	[OIL PRESS SENSOR]	Not use
	[OIL TEMP SENSOR]	Not use
	[USER TEMP SENSOR]	Not use
	[FUEL LEVEL SENSOR]	Not use
	[EXT-MODULE SENSOR 1~8]	Not use
[CONTROL]	[IDLE TIME]	5 [s]
	[CRANK OFF TIME]	15 [s]
	[AUTO STOP DELAY]	10 [s]
[PROTECTION]	[OIL PRESS LOW]	0.5 [bar]
	[COOLANT TEMP HIGH]	103 [°C]
	[OIL TEMP HIGH]	103 [°C]

7.8.1. When [EDC7C1 OFF] is set:

- [C_GOVERNOR] is not output in the Ready to run status, and ECU communication alarm does not occur.
- If Gen-set start signal is input, [C_GOVERNOR] is output during [PRE-CRANK TIME], the ECU power is turned on, and gen-set is Ready to run status.

- If gen-set is stopped, [C_GOVERNOR] output disappears and communication alarm does not occur until it is [CRANK-ON] again.

7.9. PT RATIO (PT)

- Setup PT (Potential Transformer) Ratio.
- Setup : 1 ~ 99.99
- If Gen-set rated voltage exceeds AC 550 [Vrms], PT must be used.
- Ex) When 1st PT voltage (Gen-set voltage) is 6600 [V], and when PT 2nd voltage (Input voltage) is 110 [V].

Menus that are influenced	Setup
[SYSTEM] → [VOLTAGE]	6600 [V]
[SYSTEM] → [PT RATIO]	60.0 (= 6600/110)

7.10. CT RATIO (CT)

- Setup CT (Current Transformer) Ratio.
- Setup : 5/5 ~ 9999/5 [A]

7.11. GR CT RATIO (ZCT)

- Setup ZCT (Zero Current Transformer) Ratio.
- Setup : 5/5 ~ 9999/5 [A]

7.12. RPM (RPM)

- Setup Gen-set RPM.
- Setup : 0 ~ 4000 [RPM]

7.13. GOVERNOR TYPE (GOV)

- Select type of Governor.
- Setup : FUEL, STOP

Menus that are influenced	Setup
[DO-CONFIG]	[C_GOVERNOR] port set by user

7.14. TEETH(FACTOR) (TEETH)

- Setup engine gear Teeth.
- Setup : 0 ~ 250

Set value	Description
31 ~ 250	Use MPU as RPM measurement type
20	Use voltage as RPM measurement type in 6-pole generator
30	Use voltage as RPM measurement type in 4-pole generator

7.15. BREAKER TYPE (TYPE)

- Select type of Breaker
- Setup : MCCB, ACB, MC

7.15.1. ACB CLOSE DELAY (CLOSE)

- Setup delay time before ACB close after BUILT-UP is forming in [AUTO] mode.
- Setup : 0 ~ 60 [s]

7.15.2. ACB OPEN DELAY (OPEN)

- Setup delay time before ACB open after MAINS is forming in [AUTO] mode.
- Setup : 0 ~ 60 [s]

7.15.3. START FAIL TRIP SET (TRIP)

- Select use / not use of breaker signal in case of start failure.
- Setup : Use, Not use

7.16. BREAKER AUX CHECK (AUX)

- Select use / not use of breaker auxiliary contact.
- Setup : Use, Not use

7.17. BUTTON BEEP (BEEP)

- Select use/ not use of button sound.
- Setup : Use, Not use

7.18. ALARM HORN TIME (HORN)

- Setup of internal buzzer and [C_ALARM BUZZER] output holding time when Alarm occurs.
- Setup : 0 ~ 600 [s]
- When setting is 0, internal buzzer and [C_ALARM BUZZER] will output until release of Alarm or until press of [ALARM] button.

Menus that are influenced	Setup
[DO-CONFIG]	Output holding time when [C_ALARM BUZZER] is used

7.19. BACK-LIGHT TIME (LIGHT)

- Setup backlight holding time of LCD.
- Setup : 0 ~ 600 [s]
- Backlight will not go off when set as 0 or during running.

7.20. DATE SETUP (DATE)

- Setup present date.
- Setup : Year, month, date, day

7.21. TIME SETUP (TIME)

- Setup present time.
- Setup : 00:00 ~ 23:59

7.22. TIME COMPENSATION (CLOCK)

- Adjust when time goes faster or slower.
- Setup : -31 ~ +31

7.23. PASSWORD (PASSWORD)

- Setup the password to enter the menu. (If password is unused or set to 0, it can be entered without a password.)
- Setup : 0 ~ 9999

8. SENSOR-SET

- Set up Sensor information needed in Gen-set run.
- Setup is possible in the stop state. (Some menus excluded)

Menu		Description	Setup
COOLANT TEMP SENSOR	CT	Coolant temp sensor	Use, Not Use
OIL PRESS SENSOR	OP	Oil press sensor	Use, Not Use
OIL TEMP SENSOR	OT	Oil temp sensor	Use, Not Use
USER TEMP SENSOR	UT	User temp sensor	Use, Not Use
FUEL LEVEL SENSOR	FL	Fuel level sensor	Use, Not Use
COOLANT TEMP LV1~LV8	V1~V8	Setup temp according to resistance value of sensor	0~2000 [Ω] / 0~150℃
OIL PRESS LV1~LV8	V1~V8	Setup press according to resistance value of sensor	0~2000 [Ω] / 0.0 ~16.0 [bar]
OIL TEMP LV1~LV8	V1~V8	Setup temp according to resistance value of sensor	0~2000 [Ω] / 0~150℃
USER TEMP LV1~LV8	V1~V8	Setup temp according to resistance value of sensor	0~2000 [Ω] / 0~150℃
FUEL LEVEL GAIN	GAIN	Setup fuel level Gain	0.001 ~ 9.999
FUEL LEVEL OFFSET	OFFSET	Setup fuel level Offset	0 ~ 9999

8.1. Sensor Use / Not use

- Select use / not use of Coolant temp, Oil press, Oil temp, User temp and Fuel Level sensor.
- Setup : Use, Not use

8.2. RTD Sensor Resistance Value and Output setup

- Setup output value of sensor according to RTD Sensor resistance value.
- Setup : Set output value according to V1 ~ V8

8.3. Fuel Level Gain and Offset

- 4~20 [mA] Set digital output value of fuel level sensor analog input value.
- Gain : 0.001 ~ 9.999
- Offset : 0 ~ 9999

8.4. When Using EP20

- When using EP20, press  button to switch to Ext-Module sensor setup screen.

Menu	Description	Factory Sensor Data	Type
EXT-MODULE SENSOR 1	Not use, Coolant temp, Coolant temp LH, Coolant temp RH, Oil temp, User temp 1, User temp 2	DAEWOO Temp Sensor (Recommended use of temp sensor) (PT100 recommended in user temp setup)	Resistance type
EXT-MODULE SENSOR 2			
EXT-MODULE SENSOR 3			
EXT-MODULE SENSOR 4			
EXT-MODULE SENSOR 5	Not use, Oil press, Oil press LH, Oil press RH, User press 1, User press 2	VDO press sensor (Press Sensor recommended)	
EXT-MODULE SENSOR 6			
EXT-MODULE SENSOR 7	Not use, Fuel level, Coolant level	-	Current type
EXT-MODULE SENSOR 8			

- Keep pressing [▼] button to switch to Ext-Module sensor data screen from [SENSOR-SET] screen.
- Initial setup for [EXT-MODULE SENSOR 1] ~ [EXT-MODULE SENSOR 4] are data of temp sensor and [EXT-MODULE SENSOR 5] ~ [EXT-MODULE SENSOR 6] are data of press sensor.
- Check sensor type, sensor data and setup value before using.
- DAEWOO Temp Sensor Setup

Resistance	1440	154	104	73	52	28	16	12
Temp	10	50	60	70	80	100	120	130

- VDO Temp Sensor Setup

Resistance	292	134	70	51	39	29	22	0
Temp	40	60	80	90	100	110	120	130

- PT 100 Temp Sensor Setup

Resistance	100	108	116	123	131	139	147	155
Temp	0	20	40	60	80	100	120	140

- PT 1000 Temp Sensor Setup

Resistance	1000	1078	1156	1234	1312	1391	1469	1547
Temp	0	20	40	60	80	100	120	140

- VDO Press Sensor Setup

Resistance	10	31	52	71	88	107	140	184
Press	0	10	20	30	40	50	70	100

9. DI-CONFIG

- Digital Input(DI) Setup.
- When signal of user set type(N/O, N/C) is input, set message(TEXT) will output after set delay time(0.0 ~ 25.0) and then running mode of Gen-set will switch according to Alarm Level(7 level).
- Setup possible in Stop mode. (Some menus excluded)

Item	DI List (SET)	Description	TYPE	DELAY	ALARM
Fault Contact	USER FAULT	User fault contact	[N/O] [N/C]	0.0~25.0 [s]	Total 7 levels
	USER FAULT (RUN)	User fault contact (Running)			
	USER FAULT (STOP)	User fault contact (Stop)			
	EM'CY STOP S/W	Emergency stop			
	COOLANT TEMP S/W	Coolant temp switch			
	OIL PRESS S/W	Oil press switch			
	COOLANT LEVEL S/W	Coolant level switch			
	NO CHARGING S/W	Charge failure			
	FAIL TO START	Start failure			
	FAIL TO STOP	Stop failure			
	BUILD-UP EXPIRE	Fail to Build-up			
	OVER SPEED	Over speed			
	OCGR	Ground over current			
Status Contact	BREAKER AUX	Breaker auxiliary	Impossible	Impossible	Impossible
	UVR SIGNAL	UVR run			
	FIRE-RUN	Emergency run			
	BLOCK MODE	Block mode			
	MANUAL MODE	Manual mode			
	AUTO MODE	Auto mode			
	GEN START	Gen-set start			
	GEN STOP	Gen-set stop			
	BREAKER CLOSE	Breaker close			
	BREAKER OPEN	Breaker open			
	ALARM RESET	Alarm reset			
	IDLE STATUS	IDLE run			
	GEN VOLTAGE CHANGE	Voltage change by generator wiring			
	BUZZER STOP	Stop buzzer operation			
	USER TIMER INPUT	On / Off delay signal			
			0~999.9 [s]		

- When using EP20, additional contact input setup is possible as shown below.

Menus that are influenced	Setup	Description
[SYSTEM] → [EXT-MODULE]	EP20	When using EP20
[DI-CONFIG] → From [DI 11 SET]	Relevant contact	Oil Press S/W LH
		Oil Press S/W RH
		Coolant S/W LH
		Coolant S/W RH
		Oil temp S/W

9.1. USER FAULT

- Used as user fault contact.
- When contact is input, operation mode of Gen-set will switch according to set alarm level after set delay time.
- Alarm message can be revised.
- Setup : TYPE(N/O, N/C), DELAY(0.0 ~ 25.0[s]), ALARM LEVEL(7level), MESSAGE(TEXT)

9.2. USER FAULT(RUN)

- Used as user fault contact in [RUN].
- When contact is input, operation mode of Gen-set will switch according to set alarm level after set delay time.
- Alarm message can be revised.
- Setup : TYPE(N/O, N/C), DELAY(0.0 ~ 25.0[s]), ALARM LEVEL(7level), MESSAGE(TEXT)

9.3. USER FAULT(STOP)

- Used as user fault contact in [READY].
- When contact is input, operation mode of Gen-set will switch according to set alarm level after set delay time.
- Alarm message can be revised.
- Setup : TYPE(N/O, N/C), DELAY(0.0 ~ 25.0[s]), ALARM LEVEL(7level), MESSAGE(TEXT)

9.4. EM'CY STOP S/W

- Used as Emergency stop switch contact.
- When contact is input, Gen-set will shut down.
- Setup : TYPE(N/O, N/C), DELAY(0.0 ~ 25.0[s]), ALARM LEVEL(7level), MESSAGE(TEXT)

9.5. COOLANT TEMP S/W

- Used as coolant switch contact.
- When contact is input, operation mode of Gen-set will switch according to set alarm level after set delay time.
- If coolant high temp occurs in [BUILD-UP] or [RUN] or [COOLDOWN], then [F_COOLANT TEMP HIGH] Alarm will output.
- Setup : TYPE(N/O, N/C), DELAY(0.0 ~ 25.0 [s]), ALARM LEVEL(7level)

9.6. OIL PRESS S/W

- Used as oil press switch contact.
- When contact is input, operation mode of Gen-set will switch according to set warning level after set delay time.
- If Coolant High Temp occurs in [BUILD-UP] or [RUN] or [COOLDOWN], then [F_OIL PRESS LOW] Alarm will output.
- Setup : TYPE(N/O, N/C), DELAY(0.0 ~ 25.0 [s]), ALARM LEVEL(7level)

9.7. COOLANT LEVEL S/W

- Used as coolant level switch contact.
- When contact is input, operation mode of Gen-set will switch according to set Alarm level after set delay time.
- Setup : TYPE(N/O, N/C), DELAY(0.0 ~ 25.0 [s]), ALARM LEVEL(7level)

9.8. NO CHARGING S/W

- Used as battery charging failure contact.
- When contact is input, operation mode of Gen-set will switch according to set warning level after set delay time.
- Only detects in [RUN] .
- Setup : TYPE(N/O, N/C), DELAY(0.0 ~ 25.0 [s]), ALARM LEVEL(7level)

9.9. FAIL TO START

- Used as start failure contact.
- When contact is input, operation mode of Gen-set will switch according to set warning level after set delay time.
- Setup : TYPE(N/O, N/C), DELAY(0.0 ~ 25.0 [s]), ALARM LEVEL(7level)

9.10. FAIL TO STOP

- Used as stop failure contact.
- When contact is input, operation mode of Gen-set will switch according to set warning level after set delay time.
- Setup : TYPE(N/O, N/C), DELAY(0.0 ~ 25.0 [s]), ALARM LEVEL(7level)

9.11. BUILD-UP EXPIRE

- Used as fail to build-up contact.
- When contact is input, operation mode of Gen-set will switch according to set warning level after set delay time.
- Setup : TYPE(N/O, N/C), DELAY(0.0 ~ 25.0 [s]), ALARM LEVEL(7level)

9.12. OVER SPEED

- Used as over speed contact.
- When contact is input, operation mode of Gen-set will switch according to set warning level after set delay time.
- Setup : TYPE(N/O, N/C), DELAY(0.0 ~ 25.0 [s]), ALARM LEVEL(7level)

9.13. OCGR

- Used as OCGR contact.
- When contact is input, operation mode of Gen-set will switch according to set warning level after set delay time.
- Setup : TYPE(N/O, N/C), DELAY(0.0 ~ 25.0 [s]), ALARM LEVEL(7level)

9.14. BREAKER AUX

- Used as breaker auxiliary contact.
- Setup : TYPE(N/O, N/C),

Menus that are influenced	Setup	Description
[SYSTEM] → [BREAKER AUX]	[USE]	Use of breaker aux

9.15. UVR SIGNAL

- Used as start contact in [AUTO] mode.
- When contact is input, Gen-set will start and when contact is not input, Gen-set will stop.
- Setup : TYPE(N/O, N/C),

Menus that are influenced	Setup	Description
[CONTROL] → [MAINS SENSING]	[UVR Contact]	User set DI port
[CONTROL] → [MAINS SENSING] → [AUTO-START DELAY]	0~7200 [s]	Start delay time in [AUTO] mode
[CONTROL] → [MAINS SENSING] → [AUTO-START VOLTAGE]	0~6600 [Vac]	Start voltage in [AUTO] mode.
[CONTROL] → [MAINS SENSING] → [AUTO-STOP DELAY]	0~7200 [s]	Stop delay time in [AUTO] mode
[CONTROL] → [MAINS SENSING] → [AUTO-STOP VOLTAGE]	0~6600 [Vac]	Stop Voltage in [AUTO] mode

9.16. FIRE-RUN

- Used as emergency-run contact.
- When contact is input, operation status will switch to [FIRE] mode, and after 5[s] of [PRE-CRANK] delay time, Gen-set will start.
- Operation status will be same as [AUTO] mode.
- Setup : TYPE(N/O, N/C),

9.17. BLOCK

- Used as block mode contact.
- When contact is input, operation status will switch to [BLOCK] mode.
- Setup : TYPE(N/O, N/C),

9.18. MANUAL

- Used as manual mode contact.
- When contact is input, operation status will switch to [MANUAL] mode.
- Setup : TYPE(N/O, N/C),

9.19. AUTO

- Used as auto mode contact.
- When contact is input, operation status will switch to [AUTO] mode.
- Setup : TYPE(N/O, N/C),

9.20. GEN START

- Used as Gen-set start contact.
- Gen-set will start when contact is input in [MANUAL], [READY].
- Gen-set will not stop even if contact is open after start.
- Setup : TYPE(N/O, N/C),

9.21. GEN STOP

- Used as Gen-set stop contact.
- Gen-set will stop when contact is input in [MANUAL] mode.
Gen-set will not run even if contact is open after stop.
- Setup : TYPE(N/O, N/C),

9.22. BREAKER CLOSE

- Used as breaker close contact.
- If it is not breaker trip alarm situation in [RUN] of [MANUAL] mode, breaker will close when signal is input.
- Breaker will close in [AUTO], [SCHEDULED-RUN], [SCHEDULED-RUN ACB CONTROL-MANUAL] when signal is input.
- Setup : TYPE(N/O, N/C),

Menus that are influenced	Setup	Description
[CONTROL] → [SCHEDULED-RUN ACB CONTROL]	[MANUAL]	ACB manual control in scheduled-run

9.23. BREAKER OPEN

- Used as breaker open contact.
- Breaker will open in [MANUAL], [RUN], [COOLDOWN], [STOP] when signal is input.
- Breaker will open in [AUTO], [SCHEDULED-RUN], [SCHEDULED-RUN ACB CONTROL-MANUAL] when signal is input.
- Setup : TYPE(N/O, N/C)

Menus that are influenced	Setup	Description
[CONTROL] → [SCHEDULED-RUN ACB CONTROL]	[MANUAL]	ACB manual control in scheduled-run

9.24. ALARM RESET

- Used as Alarm reset contact.
- When Alarm occurs and is released, Alarm status will be initialized when signal is input.
- When Alarm occurs and is not released, only Alarm Horn will be initialized when signal is input.
- Setup : TYPE(N/O, N/C),

9.25. IDLE RUN

- Used as IDLE contact.
- Operation status will switch to [IDLE] when contact is input.
- Setup : TYPE(N/O, N/C)

9.26. GEN VOLTAGE CHANGE

- Used as generator voltage change contact.
- It changes to the voltage state, when contact is input after changing the generator wiring.
(ex) 380V → 220V / 440V → 380V
- Setup : TYPE(N/O, N/C)

9.27. BUZZER STOP

- Used as buzzer stop contact.
- The buzzer sound stops immediately, when the contact is input.
- Setup : TYPE(N/O, N/C)

9.28. USER TIMER INPUT

- Used as user timer start contact.
- When the contact is applied, the set user timer is operated, and when the operation is completed, the set relay is output.
- After the set time, it is turned ON/OFF as a user timer relay.
(User timer ON/OFF delay setting: 0.0~999.0 sec)
- Setup : TYPE(N/O, N/C)

9.29. OIL PRESS S/W LH

- Used as left oil press switch contact when using EP20.
- [F_OIL PRESS LOW] will output when oil press low happens in [BUILD-UP], [RUN], [COOLDOWN].
- Setup : TYPE(N/O, N/C), DELAY(0.0 ~ 25.0[s]), ALARM LEVEL(7level)

9.30. OIL PRESS S/W RH

- Used as right oil press switch contact when using EP20.
- [F_OIL PRESS LOW] will output when oil press low happens in [BUILD-UP], [RUN], [COOLDOWN].
- Setup : TYPE(N/O, N/C), DELAY(0.0 ~ 25.0[s]), ALARM LEVEL(7level)

9.31. COOLANT S/W LH

- Used as left coolant switch contact when using EP20.
- [F_COOLANT TEMP HIGH] will output when COOLANT temp high happens in [BUILD-UP], [RUN], [COOLDOWN].
- Setup : TYPE(N/O, N/C), DELAY(0.0 ~ 25.0[s]), ALARM LEVEL(7level)

9.32. COOLANT S/W RH

- Used as right coolant switch contact when using EP20.
- [F_COOLANT TEMP HIGH] will output when coolant temp high happens in [BUILD-UP], [RUNNING], [COOLDOWN].
- Setup : TYPE(N/O, N/C), DELAY(0.0 ~ 25.0[s]), ALARM LEVEL(7level)

9.33. OIL TEMP S/W

- Used as [C_AIR HEATER] output contact when using EP20.
- Relevant contact can only be used when using EP20.
- Setup : TYPE(N/O, N/C),

10. DO-CONFIG

- Digital Output(DO) Setup.
- Setup possible in Stop mode. (Some items excluded)

DO List	Description	DO List	Description
C_PRE-CRANK	Pre-heat	F_OVER VOLTAGE	Over voltage
C_CRANK	Start motor	F_UNDER VOLTAGE	Under voltage
C_GOVERNOR	Solenoid	F_OVER CURRENT	Over current
C_BREAKER CLOSE	Breaker close	F_OCGR	Ground over current
C_BREAKER OPEN	Breaker open	F_OVER FREQ	Over frequency
C_ALARM BUZZER	Alarm	F_UNDER FREQ	Under frequency
C_ALARM RESET	Alarm Release	F_OVER SPEED	Over speed
C_IDLE SPEED	IDLE Speed	F_UNDER SPEED	Under speed
C_RATED SPEED	Rated Speed	F_FAIL TO START	Start failure
C_AIRHEATER	Air Heater	F_FAIL TO STOP	Stop failure
C_USER TIMER	User Timer	F_FAIL TO BUILD-UP	Build-up failure
		F_COOLANT TEMP HIGH	Coolant high temp
S_MAINS ON	Mains on status	F_COOLANT TEMP LOW	Coolant low temp
S_MAINS OFF	Mains off status	F_OIL PRESS HIGH	Oil high press
S_GEN START	Gen-set start	F_OIL PRESS LOW	Oil low press
S_GEN RUNNING	[RUN] status	F_OIL TEMP HIGH	Oil high temp
S_BLOCK MODE	[BLOCK] mode	F_OIL TEMP LOW	Oil low temp
S_MANUAL MODE	[MANUAL] mode	F_USER TEMP HIGH	User temp high
S_AUTO MODE	[AUTO] mode	F_USER TEMP LOW	User temp low
S_FIRE-RUN MODE	[FIRE] mode	F_FUEL LEVEL HIGH	Fuel level high
S_ALL ALARM	All Alarm	F_FUEL LEVEL LOW	Fuel level low
S_WARNING	Warning	F_BAT VOLT HIGH	Battery voltage high
S_HEAVY FAULT	SHT, TRIP+STOP	F_BAT VOLT LOW	Battery voltage low
S_TRIP FAULT	TRIP	F_USER PRESS HIGH	User press high
S_STOP FAULT	STOP	F_USER PRESS LOW	User press low
S_SHUTDOWN FAULT	SHT	F_COOLANT LEVEL LOW	Coolant level low
S_FUEL LEVEL	FUEL LEVEL	F_USER FAULT 1~10	User fault contact

- When using EP20, additional contact input setup possible as shown below.

Menus that are influenced	Setup	Description
[SYSTEM] → [EXT-MODULE]	EP20-1	When using EP20-1
[DO-CONFIG] → From [DO 09 SET]	Relevant contact	C_AIR HEATER

※ Only applicable in EP20

10.1. C_PRE-CRANK

- Used as output contact when pre-heating is needed in [PRE-CRANK] status.
- If Gen-set start signal is input in [READY], [C_CRANK] is output during [PRE-CRANK TIME] then status will switch to [CRANK-ON].

Menus that are influenced	Setup	Description
[CONTROL] → [PRE-CRANK TIME]	0 ~ 60 [s]	[C_PRE-CRANK] will output during set time

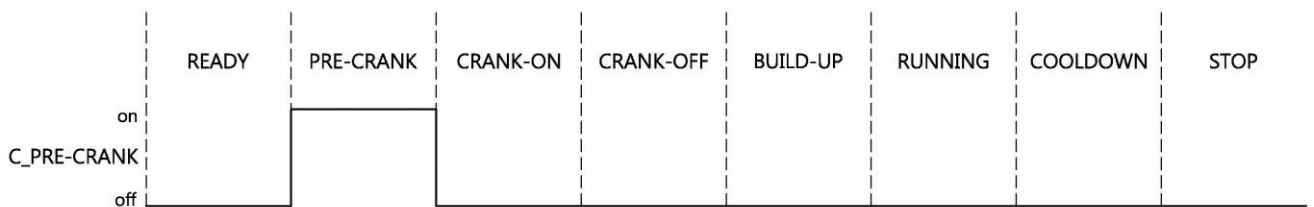

〈 [C_PRE-CRANK] output according to operation mode 〉

10.2. C_CRANK

- Used as start motor output contact in [CRANK-ON] status.

Menus that are influenced	Setup	Description
[CONTROL] → [CRANK-ON TIME]	1 ~ 9 [s]	[C_CRANK] will output during set time

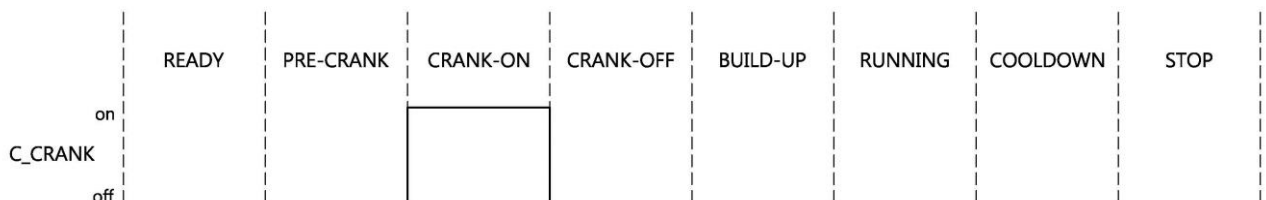

〈 [C_CRANK] output according to operation mode 〉

10.3. C_GOVERNOR

- Used as governor output contact.

Menus that are influenced	Setup	Description
[SYSTEM] → [RPM] → [GOVERNOR TYPE]	FUEL, STOP	Refer to picture shown below

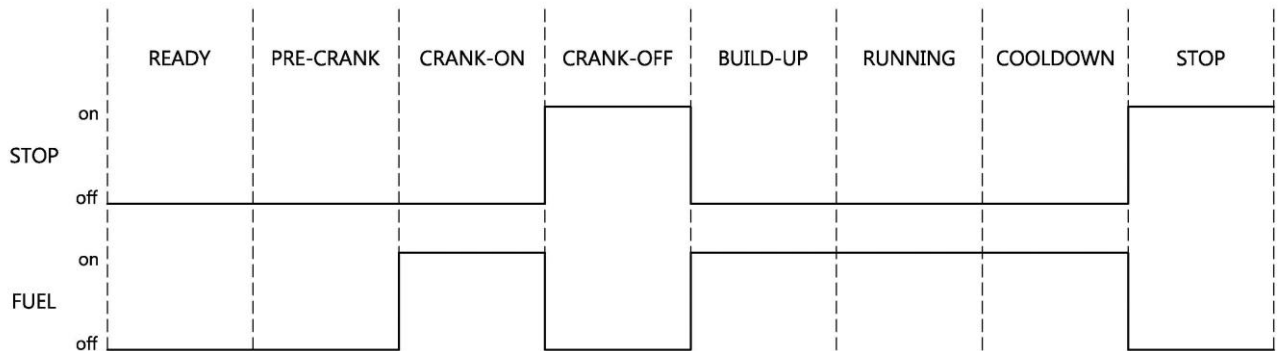

< [C_GOVERNOR] output according to operation status >

10.4. C_BREAKER CLOSE

- Used as Breaker Close output contact in [RUN] when status is not BREAKER TRIP ALARM.
- If [BREAKER TYPE] is ACB in [MANUAL] mode, press [CLOSE] to activate.
- If [BREAKER TYPE] is ACB in [AUTO] or [FIRE], Breaker Close contact will output after set delay time.
- Will output according to setup of [SCHEDULED-RUN ACB CONTROL] in [SCHEDULED-RUN].

Menus that are influenced	Setup	Description
[CONTROL] → [BREAKER TYPE]	ACB	Breaker Close output
[CONTROL] → [ACB CLOSE DELAY TIME]	0~60 [s]	Close contact output after set time
[CONTROL] → [SCHEDULED-RUN]	Use	Setup scheduled-run
[CONTROL] → [SCHEDULED-RUN] → [SCHEDULED-RUN ACB CONTROL]	Manual, Auto	Setup control method of scheduled-run ACB

10.5. C_BREAKER OPEN

- Used as breaker open output contact in [RUN], [COOLDOWN], [STOP]. (Holding time for 2 [s])
- Press [OPEN] to activate in [MANUAL] mode.
- Breaker Open contact will output automatically in [AUTO] or [FIRE].
- Output can be setup in [AUTO] or [MANUAL] mode according to [SCHEDULED-RUN ACB CONTROL] in [SCHEDULED-RUN] status.
- If Breaker type is MCCB, Breaker Open contact will output only in Breaker Trip Alarm.

Menus that are influenced	Setup	Description
[CONTROL] → [SCHEDULED-RUN]	Use	Setup scheduled-run
[CONTROL] → [SCHEDULED-RUN] → [SCHEDULED-RUN ACB CONTROL]	MANUAL, AUTO	Setup scheduled-run ACB control method
[CONTROL] → [BREAKER TYPE]	MCCB	Use MCCB

10.6. C_ALARM BUZZER

- Used as Alarm Buzzer output contact when Warning, Trip, Shut down occurs.
- When Alarm occurs, contact will output during [ALARM HORN TIME], and when it is set as 0, Alarm Reset is only possible manually.

Menus that are influenced	Setup	Description
[SYSTEM] → [BUTTON BEEP] → [ALARM HORN TIME]	0 ~ 600 [s]	Contact output during set time

10.7. C_ALARM RESET

- Used as alarm reset contact.
- Signal will output during input of [ALARM RESET] or during activation of [RESET] button.

10.8. C_IDLE SPEED

- Used as IDLE speed output contact
- If [IDLE RUN] is input, contact output will continue regardless of Run status.
- If [IDLE RUN] is not input, contact will output during set [IDLE TIME].

Menus that are influenced	Setup	Description
[DI-CONFIG] → [IDLE RUN]	Use	Contact output during [IDLE RUN] input
[CONTROL] → [IDLE TIME]	0 ~ 60[s]	Contact output during set time

10.9. C_RATED SPEED

- Used as rated speed output contact.
- If [IDLE TIME] is not 0 in [BUILD-UP] status, [C_IDLE SPEED] will output, and if [IDLE TIME] is 0, [C_RATED SPEED] will output.

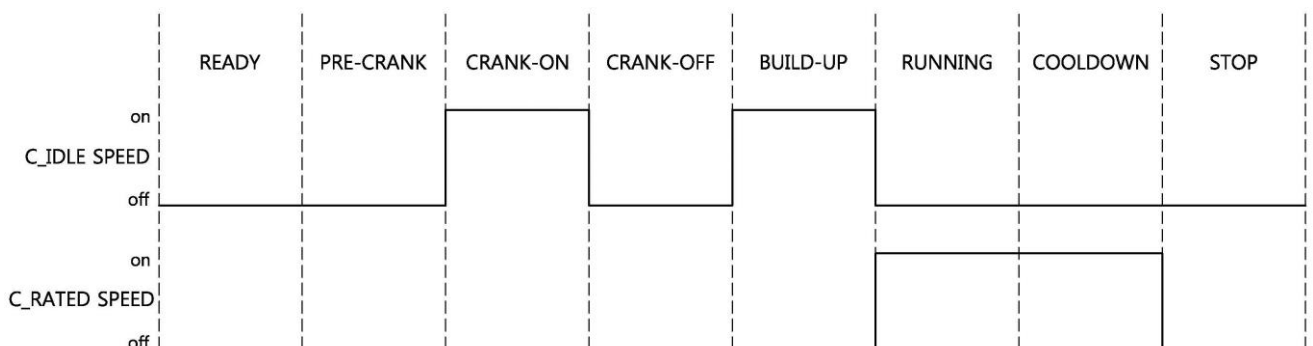

< [C_IDLE SPEED], [C_RATED SPEED] output according to Gen-set status >

10.10. C_AIR HEATER

- Used as output contact when using Air-heater in [BUILD-UP].
- When using EP20, use of relevant contact is only available in EP20.
- After setup of Air Heater in [CONTROL], setup relevant output contact in [DO-CONFIG].
- If oil temp is lower than [OIL TEMP SWITCH] input status or set [A/H OPERATED TEMP], relevant contact will output in [BUILD-UP] status.
- Once it is output, holding time will be as set [A/H OPERATED TIME].
- Output will occur only once during Running of Gen-set and then will output again when Gen-set re-starts.

Menus that are influenced	Setup	Description
[CONTROL] → [EXT-MODULE]	EP20	When using EP20
[DO-CONFIG] → From [DO 09 SET]	Relevant contact	Only applicable in EP20
[CONTROL] → [A/H INPUT TYPE]	Use/ Not use	Not use, switch, sensor, switch+sensor
[CONTROL] → [A/H OPERATED TEMP]	Run temp	Digital output in temp below set temp
[CONTROL] → [A/H OPERATED TIME]	Run time	Output holding time

10.11. C_USER TIMER

- Used as output contact when using Air-heater in [BUILD-UP].
- It turns ON after as much as the ON delay time set by the User timer ON signal has elapsed.

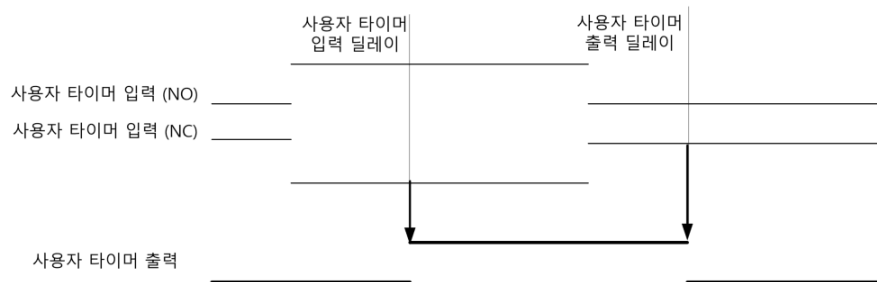

10.12. S_MAINS ON

- Used as Mains On output.

10.13. S_MAINS OFF

- Used as Mains off output.

10.14. S_GEN START

- Used as Gen-set start output.

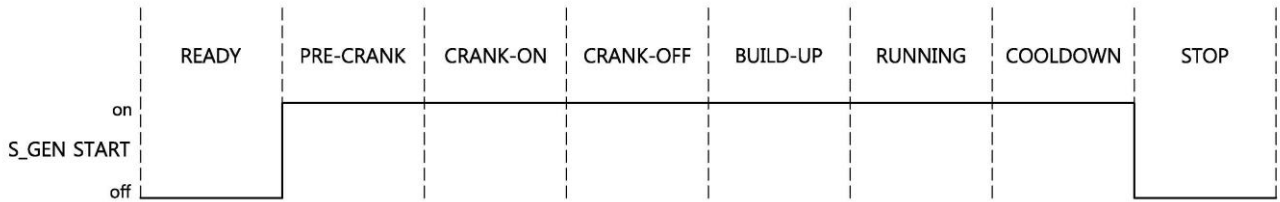

〈 [S_GEN START] output according to status of Gen-set 〉

10.15. S_GEN RUNNING

- Used as Gen-set running output.

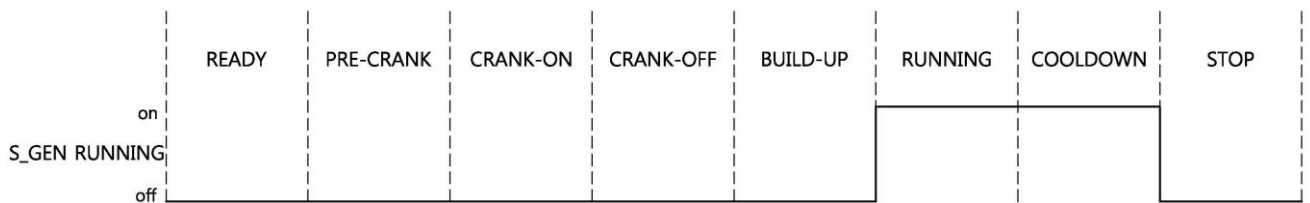

〈 [S_GEN RUNNING] output according to Gen-set status 〉

10.16. S_BLOCK MODE, S_MANUAL MODE, S_AUTO MODE, S_FIRE-RUN

- Used as output contact of each mode.

10.17. S_ALL ALARM, S_WARNING, S_HEAVY FAULT, S_TRIP FAULT, S_STOP FAULT, S_SHUTDOWN FAULT

- Used as output contact of each Alarm status.

- Output will stop when Alarm is released.

10.18. S_FUEL LEVEL

- Used as gen-set fuel level status output contact.

10.19. Alarm Status

- Used as output contact of each Alarm status.

- Output will stop when Alarm is released.

- Setup of OVR, UVR, OCR, OCGR, OFR, UFR, OSR, USR, FAIL to start, FAIL to stop, FAIL to build-up, CT high, CT low, OP high, OP low, OT high, OT low, UT high, UT low, FL high, FL low, BAT VOLT high, BAT VOLT low, USER PRESS high, USER PRESS low, COOLANT LEVEL low

10.20. Alarm Contacts1 ~10

- Used as Alarm contact of User Fault.
- Output will stop when User Fault is released.

11. CONTROL

- Setup Gen-set operation status.

Items		Description	Setup
MAINS SENSING	TYPE	Setup Mains Sensing method	R-S, R-S-T , UVR
AUTO-START DELAY	T1	Auto-Start delay time when Mains Off	0 ~ 7200 [s]
AUTO-STOP DELAY	T2	Auto-Stop delay time when Mains On	0 ~ 7200 [s]
AUTO-START VOLTAGE	V1	Setup voltage level to recognize as Mains off when Mains Sensing is 'MAIN R-S' or 'MAIN R-S-T'	0 ~6600 [V]
AUTO-STOP VOLTAGE	V2	Setup voltage level to recognize as Mains On when Mains Sensing is 'MAIN R-S' or 'MAIN R-S-T'	0 ~ 6600 [V]
SCHEDULED-RUN	TYPE	Setup use/not use and using method of Scheduled-Run	Not use, date, day
SCHEDULED -RUN SETUP	SETUP	Setup date when Scheduled-Run is [DATE] Setup day when Scheduled-Run is [DAY]	1 ~ 31 Mon ~ Sun
SCHEDULED -RUN ACB	CB	Setup ACB control type in Scheduled-Run	Manual, Auto
SCHEDULED -RUN START	ON	Setup start time of Scheduled-Run	00:00 ~ 23:59
SCHEDULED -RUN STOP	OFF	Setup stop time of Scheduled-Run	00:00 ~ 23:59
PRE-CRANK TIME	PRE	Relay output time of Pre-Crank	0 ~ 60 [s]
CRANK-ON TIME	ON	Crank max output time	1 ~ 99 [s]
CRANK-OFF TIME	OFF	Delay time until next crank when repeating	5 ~ 60 [s]
CRANK ATTEMPTS	REPEAT	Number of Crank repeat in AUTO Mode	1 ~ 9
GOV DELAY	GOV	Delay time of [C_GOVERNOR] output after [C_CRANK] output	-60 ~ +60 [s]
CRANK ON CHECK TIME	CHECK	Check time if Run-state is completed	1 ~ 99 [s]
RUN-STATE RPM	RPM	RPM to check engine crank No check when set to 0 (initial value 400)	100 ~ 1200 [rpm]
RUN-STATE OP-GAUGE	OPG	Oil press to check engine crank No check when set to 0	0.0 ~ 16.0 [bar]
RUN-STATE OP-SWITCH	OPS	Use/Not use of oil press switch to check engine crank	Use, Not use
OIL PRESS DEAD-TIME	OPDT	Delay time of oil press low protection after engine crank	0 ~ 30 [s]

Items		Description	Setup
IDLE TIME	IDLE	Setup time for IDLE-RUN IDLE Relay will output during set time	0 ~ 600 [s]
BUILD-UP EXPIRE	BUILD-UP	If voltage, frequency, and RPM don't build-up within set time after cranking, Build-up Failure fault will occur	5 ~ 600 [s]
ACB CLOSE DELAY	CLOSE	ACB Close delay time in AUTO Mode	0 ~ 60 [s]
COOLDOWN TIME	COOLDOWN	Setup cooldown time in AUTO Mode	0 ~ 600 [s]
STOP-HOLD TIME	STOP	Stop signal holding time	0 ~ 600 [s]
A/H INPUT TYPE	TYPE	[C_AIR HEATER] setup of use/not use and operation method	Not used, sensor, switch, sensor+switch
A/H OPERATED TEMP	TEMP	[C_AIR HEATER] output in temp lower than set value	0 ~ 99 [°C]
A/H OPERATED TIME	TIME	[C_AIR HEATER] output holding time	0 ~ 180 [s]

12. PROTECTION

- Setup of Protection during Running or Stop.
 - Setup impossible during running.
 - In case of OVR, OCR, and OCGR, Constant and Inverse will operate at the same time.
- Duplicate operation in Instant setup.

Items		Description	Setup
OVR	CONSTANT	Start from over voltage level	0.5 ~ 20.0 [s]
	INVERSE	Start from over voltage level	Refer to Inverse Characteristics Curve
	INSTANT	Start from over voltage level	Within 200ms (The higher the input voltage, time will decrease)
OCR	CONSTANT	Start from over current level	0.5 ~ 20.0 [s]
	INVERSE	Start from over current level	Refer to Inverse Characteristics Curve
	SET	Start from 200% of rated current	Within 200ms (The higher the input current, time will decrease)
OCGR	CONSTANT	Start from ground over current level	0.5 ~ 20.0 [s]
	INVERSE	Start from ground over current level	Refer to Inverse Characteristics Curve
	SET	Start from 200% of ground current level	Within 200ms (The higher the input current, time will decrease)

Items		Description	Setup
OVR	SET	Setup level for over voltage (constant)	100 ~ 150 [%]
	DLY	Setup constant delay time for over voltage	0.5 ~ 20.0 [s]
	LVR	Setup inverse lever for over voltage	0.05 ~ 1.0
	ARM	Setup protection level for over voltage	Refer to chart below
	INS	Setup instant for over voltage	Use, Not use
	SET	Setup level for over voltage (instant)	100 ~ 150 [%]
	SVR	Check time delay for over voltage (instant) after GEN RUNNING	0 ~ 60 [s]
UVR	SET	Setup level for under voltage	50 ~ 100 [%]
	DELAY	Setup delay time for under voltage	0.5 ~ 20.0 [s]
	ALARM	Setup protection level for under voltage	Refer to chart below
OCR	SET	Setup for over current	101 ~ 200 [%]
	DELAY	Setup delay time for over current	0.5 ~ 20.0 [s]
	LEVER	Setup characteristics lever for over current	0.05 ~ 1.0
	INST	Setup instant for over current	Use, Not use
	ALARM	Protection level for over current	Refer to chart below
OCGR	SET	Setup level for OCGR	101 ~ 200 [%]
	DELAY	Setup delay time for OCGR	0.5 ~ 20.0 [s]
	LEVER	Setup characteristics lever for OCGR	0.05 ~ 1.0
	INST	Setup instant for OCGR	Use, Not use
	ALARM	Protection level for OCGR	Refer to chart below
OFR	SET	Setup level for over frequency	100 ~ 150 [%]
	DELAY	Setup delay time for over frequency	0.5 ~ 20.0 [s]
	ALARM	Protection level for over frequency	Refer to chart below
UFR	SET	Setup level for under frequency	50 ~ 100 [%]
	DELAY	Setup delay time for under frequency	0.5 ~ 20.0 [s]
	ALARM	Protection level for under frequency	Refer to chart below
OSR	SET	Setup level for Over Speed	100 ~ 150 [%]
	DELAY	Setup delay time for Over Speed	0.1 ~ 1.0
	ALARM	Setup protection level for Over Speed	Refer to chart below
USR	SET	Setup level for Under Speed	50 ~ 100 [%]
	DELAY	Setup delay time for Under Speed	0.5 ~ 20.0 [s]
	ALARM	Setup protection level for Under Speed	Refer to chart below

Items		Description	Setup
COOLANT TEMP HIGH	HIGH	Setup level for Coolant Temp High	0 ~ 150 [°C]
	ALARM	Setup protection level for Coolant Temp High	Refer to chart below
COOLANT TEMP LOW	LOW	Setup level for Coolant Temp Low	0 ~ 150 [°C]
	ALARM	Setup protection level for Coolant Temp Low	Refer to chart below
OIL PRESS HIGH	HIGH	Setup level for Oil Press High	0.0 ~ 16.0 [bar]
	ALARM	Setup protection level for Oil Press High	Refer to chart below
OIL PRESS LOW	LOW	Setup level for Oil Press Low	0.0 ~ 16.0 [bar]
	ALARM	Setup protection level for Oil Press Low	Refer to chart below
OIL TEMP HIGH	HIGH	Setup level for Oil Temp High	0 ~ 150 [°C]
	ALARM	Setup protection level for Oil Temp High	Refer to chart below
OIL TEMP LOW	LOW	Setup level for Oil Temp Low	0 ~ 150 [°C]
	ALARM	Setup protection level for Oil Temp Low	Refer to chart below
USER TEMP HIGH	HIGH	Setup level for User Temp High	0 ~ 150 [°C]
	ALARM	Setup protection level for User Temp High	Refer to chart below
USER TEMP LOW	LOW	Setup level for User Temp Low	0 ~ 150 [°C]
	ALARM	Setup protection level for User Temp Low	Refer to chart below
FUEL LEVEL HIGH	HIGH	Setup level for Fuel Level High	0 ~ 100 [%]
	ALARM	Setup protection level for Fuel Level High	Refer to chart below
FUEL LEVEL LOW	LOW	Setup level for Fuel Level Low	0 ~ 100 [%]
	ALARM	Setup protection level for Fuel Level Low	Refer to chart below
BAT VOLTAGE HIGH	HIGH	Setup level for Battery Voltage High	8 ~ 35 [V]
	ALARM	Setup protection level for Battery Voltage High	Refer to chart below
BAT VOLTAGE LOW	LOW	Setup level for Battery Voltage Low	8 ~ 35 [V]
	ALARM	Setup protection level for Battery Voltage Low	Refer to chart below
STOP FAILURE	SET	Setup Stop Failure	Use, Not use

- Setup possible alarm levels are as follows.

Alarm types	ALARM	BREAKER OPEN	COOLDOWN	STOP
NOT USE	-	-	-	-
WARNING	○	-	-	-
TRIP	○	○	-	-
STOP	○	-	○	○
SHUTDOWN	○	-	-	○
TRIP+STOP	○	○	○	○
TRIP+SHUTDOWN	○	○	-	○

13. SERIAL COMM

- NeoGCP i7 PLUS+ has 2 comm ports.
- Setup of D-SUB 9pin is fixed as UART communication port.

Items		Description	Setup
UART ID	ID	Setup device ID for UART port	002
UART BAUD RATE	BAUD	Setup Baud Rate for UART port	9600
UART PARITY	PARITY	Setup Parity for UART port	EVEN

- RS485 ± setup through port number [12], [13] are as shown below.

Items		Description	Setup
RS485 ID	ID	Setup device ID for RS485	0 ~ 255
RS485 BAUD RATE	BAUD	Setup Baud rate for RS485 port	9600, 19200, 38400
RS485 PARITY	PARITY	Setup Parity for RS485 port	NONE, EVEN, ODD
RS485 PROTOCOL	PROTOCOL	Setup RS485 protocol	MODBUS, GIMAC-II Plus
RS485 WORD SWAP	SWAP	If RS485 protocol is GIMAC-II Plus, select WORD SWAP use/not use	Use, Not use

14. GAIN-SET

- If actual voltage and current values are different from displayed voltage and current values, change of value is possible by changing Gain setup.

Items		Description	Setup
PT U-V GAIN	PT-UV	Gain for Gen U-V Voltage	0.001 ~ 9.999
PT V-W GAIN	PT-VW	Gain for Gen V-W Voltage	0.001 ~ 9.999
PT W-U GAIN	PT-WU	Gain for Gen W-U Voltage	0.001 ~ 9.999
CT U GAIN	CT-U	Gain for Gen U Current	0.001 ~ 9.999
CT V GAIN	CT-V	Gain for Gen V Current	0.001 ~ 9.999
CT W GAIN	CT-W	Gain for Gen W Current	0.001 ~ 9.999
CT GR GAIN	CT-GR	Gain for Gen Ground Current	0.001 ~ 9.999
MAIN R-S GAIN	MAIN-RS	Gain for Main R-S Voltage	0.001 ~ 9.999
MAIN S-T GAIN	MAIN-ST	Gain for Main S-T Voltage	0.001 ~ 9.999
BAT VOLT GAIN	BAT-V	Gain for Battery Voltage	0.001 ~ 9.999
CT U OFFSET	CT-U	Offset for Gen U Current	0 ~ 100
CT V OFFSET	CT-V	Offset for Gen V Current	0 ~ 100
CT W OFFSET	CT-W	Offset for Gen W Current	0 ~ 100
CT GR OFFSET	CT-GR	Offset for Gen GR Current	0 ~ 100
Filter	F	Filtering for Gen-set Current variability	0 ~ 100
CT U SUB GAIN※	CT-U	Sub gain for Gen U Current	-200 ~ +200
CT V SUB GAIN※	CT-V	Sub gain for Gen V Current	-200 ~ +200
CT W SUB GAIN※	CT-W	Sub gain for Gen W Current	-200 ~ +200
CT GR SUB GAIN※	CT-GR	Sub gain for Gen GR Current	-200 ~ +200

※ The method of compensating gen-set current error according to the load :

- In NeoGCP i7 PLUS+, gen-set current gain is set at 30% of the load, and if an error occurs depending on the size of the load, you can adjust the sub gain. It is 0 when shipped from the factory.

[Caution] If you want to change the current gain, you must set the sub-gain to 0.

15. PROTECTION TEST

- Test setup can be changed in [PROTECTION].

Items	Description	Setup
OVER VOLTAGE TEST	200% of rated voltage at start-up	Change in [PROTECTION]
UNDER VOLTAGE TEST	-	
OVER CURRENT TEST	200% of rated current at start-up	
OCGR TEST	200% of OCGR at start-up	
OVER SPEED TEST	-	
OIL PRESS S/W TEST	Suggested to check actual wiring	
COOLANT S/W TEST	Suggested to check actual wiring	
COOLANT TEMP HIGH TEST	-	
OIL PRESS LOW TEST	-	

16. HISTORY

- Alarm History check is possible only in [BLOCK] mode.
- Check up to 30 Gen-set operation information in sequence in case of alarm history, cranking output history and alarm occurrence.
- Start motor ON/OFF record stored in ALARM HISTORY.

17. Fault Items

17.1. Generator Related Fault Items

Items	Alarm Level					Delay Time	Sequence applied
	Not use	Warning	Trip	Stop	Shutdown		
OVR	○	○	○	○	○	Setup	Always
	Gen Voltage detected higher than set value						
UVR	○	○	○	○	○	Setup	Running
	Gen Voltage detected lower than set value						
OCR	○	○	○	○	○	Setup	Always
	Gen Current detected higher than set value						
OCGR	○	○	○	○	○	Setup	Always
	Gen Ground Current detected higher than set value OCGR input						
OFR	○	○	○	○	○	Setup	Always
	Gen Frequency detected higher than set value						
UFR	○	○	○	○	○	Setup	Running
	Gen Frequency detected lower than set value						
FAIL TO BUILD-UP			◎		◎	0[s]	Build-Up
	Voltage, frequency, and RPM don't build-up within the normal range during the gen-set delay time for build-up after cranking.						
GEN BREAKER FAILURE		◎				0[s]	Always
	When Breaker Close output occurs and then Breaker Aux contact is not input						
SHORT CIRCUIT					◎	0[s]	Always
	Gen Current detected higher than short circuit level						

◎ : Fixed item ○ : Optional item

17.2. Engine Related Fault Items

Items	Alarm Level					Delay Time	Sequence applied
	Not use	Warning	Trip	Stop	Shutdown		
OVER SPEED	○	○	○	○	○	Setup	Always
	RPM detected higher than set value						
UNDER SPEED	○	○	○	○	○	Setup	RUNNING
	RPM detected lower than set value						
EM'CY STOP			◎		◎	0[s]	Always
	Emergency Stop input						
FAIL TO START			◎		◎	0[s]	CRANK-ON
	Crank Attempts expire in Auto Mode & Fire-Run Mode						
FAIL TO STOP			◎		◎	2[s]	PRE-CRANK
	Fail to Stop input						
FAIL TO STOP(RPM)	○	○	○	○	○	2[s]	PRE-CRANK
	RPM detected higher than RUN-STATE RPM						
FAIL TO STOP(OP GAUGE)	○	○	○	○	○	2[s]	PRE-CRANK
	Oil Pressure detected higher than RUN-STATE OP-GAUGE						
FAIL TO STOP(OP SWITCH)	○	○	○	○	○	2[s]	PRE-CRANK
	No input of Oil Pressure S/W						
COOLANT TEMP S/W	○	○	○	○	○	Setup	BUILD-UP ~ COOLDOWN
	Coolant Temp S/W input						
OIL PRESS S/W	○	○	○	○	○	Setup	BUILD-UP ~ COOLDOWN
	Oil Press S/W input						
NO CHARGING S/W	○	○	○	○	○	Setup	RUNNING
	No Charging S/W input						
COOLANT LEVEL S/W	○	○	○	○	○	Setup	Always
	Coolant Level S/W input						
BAT VOLTAGE HIGH	○	○	○	○	○	10[s]	Always
	Battery Voltage detected higher than set value.						
BAT VOLTAGE LOW	○	○	○	○	○	10[s]	Always
	Battery Voltage detected lower than set value.						
MPU FAILURE		◎				5[s]	BUILD-UP ~ COOLDOWN
	When using RPM measurement method as MPU and RPM is detected 0						

◎ : Fixed item ○ : Optional item

17.3. Sensor Related Fault Items

Items	Alarm Level					Delay Time	Sequence applied
	Alarm Level	Delay Time	Sequence applied	Alarm Level	Delay Time		
COOLANT TEMP HIGH	○	○	○	○	○	1 [s]	RUNNING ~ COOLDOWN
	Coolant Temperature detected higher than set value						
COOLANT TEMP LOW	○	○	○	○	○	1 [s]	RUNNING ~ COOLDOWN
	Coolant Temperature detected lower than set value						
OIL PRESS HIGH	○	○	○	○	○	1 [s]	BUILD-UP ~ COOLDOWN
	Oil Pressure detected higher than set value						
OIL PRESS LOW	○	○	○	○	○	1 [s]	BUILD-UP ~ COOLDOWN
	Oil Pressure detected lower than set value						
OIL TEMP HIGH	○	○	○	○	○	1 [s]	RUNNING ~ COOLDOWN
	Oil Temperature detected higher than set value						
OIL TEMP LOW	○	○	○	○	○	1 [s]	RUNNING ~ COOLDOWN
	Oil Temperature detected lower than set value						
USER TEMP HIGH	○	○	○	○	○	1 [s]	RUNNING ~ COOLDOWN
	User's Temperature detected higher than set value						
USER TEMP LOW	○	○	○	○	○	1 [s]	RUNNING ~ COOLDOWN
	User's Temperature detected lower than set value						
FUEL LEVEL HIGH	○	○	○	○	○	10 [s]	Always
	Fuel Level detected higher than set value						
FUEL LEVEL LOW	○	○	○	○	○	10 [s]	Always
	Fuel Level detected lower than set value						
COOLANT TEMP SENSOR		◎				5 [s]	Always
	Coolant Temperature Sensor not connected						
OIL PRESS SENSOR		◎				5 [s]	Always
	Oil Pressure Sensor not connected						
OIL TEMP SENSOR		◎				5 [s]	Always
	Oil Temperature Sensor not connected						
USER TEMP SENSOR		◎				5 [s]	Always
	User's Temperature Sensor not connected						
FUEL LEVEL SENSOR		◎				5 [s]	Always
	Fuel Level Sensor not connected						

◎ : Fixed item ○ : Optional item

17.4. Digital Input Related Fault

Items	Alarm Level					Delay Time	Sequence applied
	Alarm Level	Delay Time	Sequence applied	Alarm Level	Delay Time		
DI 1 USER FAULT	○	○	○	○	○	Setup	Always
	When DI #1 is set as USER FAULT, USER FAULT (RUN), USER FAULT (STOP) input message will be displayed						
DI 2 USER FAULT	○	○	○	○	○	Setup	Always
	When DI #2 is set as USER FAULT, USER FAULT (RUN), USER FAULT (STOP) input message will be displayed						
DI 3 USER FAULT	○	○	○	○	○	Setup	Always
	When DI #3 is set as USER FAULT, USER FAULT (RUN), USER FAULT (STOP) input message will be displayed						
DI 4 USER FAULT	○	○	○	○	○	Setup	Always
	When DI #4 is set as USER FAULT, USER FAULT (RUN), USER FAULT (STOP) input message will be displayed						
DI 5 USER FAULT	○	○	○	○	○	Setup	Always
	When DI #5 is set as USER FAULT, USER FAULT (RUN), USER FAULT (STOP) input message will be displayed						
DI 6 USER FAULT	○	○	○	○	○	Setup	Always
	When DI #6 is set as USER FAULT, USER FAULT (RUN), USER FAULT (STOP) input message will be displayed						
DI 7 USER FAULT	○	○	○	○	○	Setup	Always
	When DI #7 is set as USER FAULT, USER FAULT (RUN), USER FAULT (STOP) input message will be displayed						
DI 8 USER FAULT	○	○	○	○	○	Setup	Always
	When DI #8 is set as USER FAULT, USER FAULT (RUN), USER FAULT (STOP) input message will be displayed						
DI 9 USER FAULT	○	○	○	○	○	Setup	Always
	When DI #9 is set as USER FAULT, USER FAULT (RUN), USER FAULT (STOP) input message will be displayed						
DI 10 USER FAULT	○	○	○	○	○	Setup	Always
	When DI #10 is set as USER FAULT, USER FAULT (RUN), USER FAULT (STOP) input message will be displayed						

◎ : Fixed item ○ : Optional item

17.5. EP20 Related Alarm

- If communication does not occur within 5 seconds, EP20 comm alarm will output.
- If EP20 comm alarm occurs, [C_CRANK] will not output.

Items	Alarm Level					Delay Time	Sequence Applied
	Not use	Warning	Trip	Stop	Shutdown		
EP20 Comm Alarm		◎				5[s]	Always
	When communication with EP20 does not occur within 5 seconds.						

- Setup of EXT-MODULE SENSOR alarm level and high/low value in [PROTECTION].

Items	Alarm Level					Delay Time	Sequence Applied
	Not use	Warning	Trip	Stop	Shutdown		
USER TEMP 2 HIGH	○	○	○	○	○	2[s]	BUILD-UP ~ COOLDOWN
	User Temperature 2 detected higher than set value						
USER TEMP 2 LOW	○	○	○	○	○	2[s]	BUILD-UP ~ COOLDOWN
	User Temperature 2 detected lower than set value						
USER TEMP 2 SENSOR		⊙				5[s]	Always
	User Temperature 2 Sensor not connected						
COOLANT TEMP LH HIGH	○	○	○	○	○	2[s]	BUILD-UP ~ COOLDOWN
	Left Coolant Temperature detected higher than value						
COOLANT TEMP LH LOW	○	○	○	○	○	2[s]	BUILD-UP ~ COOLDOWN
	Left Coolant Temperature detected lower than set value						
COOLANT TEMP LH SENS		⊙				5[s]	Always
	Left Coolant Temperature Sensor not connected						
COOLANT TEMP RH HIGH	○	○	○	○	○	2[s]	BUILD-UP ~ COOLDOWN
	Right Coolant Temperature detected higher than set value						
COOLANT TEMP RH LOW	○	○	○	○	○	2[s]	BUILD-UP ~ COOLDOWN
	Right Coolant Temperature detected lower than set value						
COOLANT TEMP RH SENS		⊙				5[s]	Always
	Right Coolant Temperature Sensor not connected						
OIL PRESS LH HIGH	○	○	○	○	○	2[s]	BUILD-UP ~ COOLDOWN
	Left Oil Pressure Value detected higher than set value						
OIL PRESS LH LOW	○	○	○	○	○	2[s]	BUILD-UP ~ COOLDOWN
	Left Oil Pressure Value detected lower than set value						
OIL PRESS LH SENSOR		⊙				5[s]	Always
	Left Oil Pressure Sensor not connected						
OIL PRESS RH HIGH	○	○	○	○	○	2[s]	BUILD-UP ~ COOLDOWN
	Right Oil Pressure detected higher than set value						
OIL PRESS RH LOW	○	○	○	○	○	2[s]	BUILD-UP ~ COOLDOWN
	Right Oil Pressure Value detected lower than set value						
OIL PRESS RH SENSOR		⊙				5[s]	Always
	Right Oil Pressure Sensor not connected						
USER PRESS 1 HIGH	○	○	○	○	○	2[s]	BUILD-UP ~ COOLDOWN
	User Temperature 1 detected higher than set value						

Items	Alarm Level					Delay Time	Sequence Applied
	Not use	Warning	Trip	Stop	Shutdown		
USER PRESS 1 LOW	○	○	○	○	○	2s	RUNNING ~ COOLDOWN
	User Temperature 1 detected lower than set value						
USER PRESS 1 SENSOR		◎				5s	Always
	User Pressure 1 sensor not connected						
USER PRESS 2 HIGH	○	○	○	○	○	2s	RUNNING ~ COOLDOWN
	User Pressure 2 detected higher than set value						
USER PRESS 2 LOW	○	○	○	○	○	2s	RUNNING ~ COOLDOWN
	User Pressure 2 detected lower than set value						
USER PRESS 2 SENSOR		◎				5s	Always
	User pressure 2 sensor not connected						
COOLANT LEVEL HIGH	○	○	○	○	○	10s	Always
	Coolant Level detected higher than set value						
COOLANT LEVEL LOW	○	○	○	○	○	10s	Always
	Coolant Level detected lower than set value						
COOLANT LEVEL SENSOR		◎				5s	Always
	Coolant Level sensor not connected						

◎ : Fixed item ○ : Optional item

18. Comm Protocol- MODBUS

18.1. MODBUS PROTOCOL

Items	Setup
Protocol Type	MODBUS RTU
Communication configuration	RS485 Half Duplex
Device ID Setup	0 ~ 255
Baud Rate Setup	9600, 19200, 38400 [bps]
Parity Setup	Even, Odd, None
Data Bit	8 [bit]
Stop Bit	1 [bit]
Support Function Code	Request(04h), Command(05h)
Frame-End Silent Interval	Firmware under V2.66 : 50 [ms], Firmware over V2.67 : 5 [ms]

18.1.1. REQUEST (04h)

ADDRESS	DATA	TYPE	SCALE
01	SERIAL NUMBER	16bit UNSIGNED INT	1
02	PROGRAM VERSION	16bit UNSIGNED INT	/100
03	AVERAGE L-L GEN VOLTAGE	16bit SIGNED INT	1
04	AVERAGE L-N GEN VOLTAGE	16bit SIGNED INT	1
05	AVERAGE GEN CURRENT	16bit SIGNED INT	1
06	GEN U-V VOLTAGE [V]	16bit SIGNED INT	1
07	GEN V-W VOLTAGE [V]	16bit SIGNED INT	1
08	GEN W-U VOLTAGE [V]	16bit SIGNED INT	1
09	GEN U-N VOLTAGE [V]	16bit SIGNED INT	1
10	GEN V-N VOLTAGE [V]	16bit SIGNED INT	1
11	GEN W-N VOLTAGE [V]	16bit SIGNED INT	1
12	GEN U CURRENT [A]	16bit SIGNED INT	1
13	GEN V CURRENT [A]	16bit SIGNED INT	1
14	GEN W CURRENT [A]	16bit SIGNED INT	1
15	GEN GROUND CURRENT [A]	16bit SIGNED INT	1
16	MAINS R-S VOLTAGE [V]	16bit SIGNED INT	1
17	MAINS S-T VOLTAGE [V]	16bit SIGNED INT	1
18	ENGINE SPEED [RPM]	16bit SIGNED INT	1
19	FREQUENCY [Hz]	16bit SIGNED INT	/10
20	ACTIVE POWER [kW]	16bit SIGNED INT	1
21	APPARENT POWER [kVA]	16bit SIGNED INT	1
22	REACTIVE POWER [kvar]	16bit SIGNED INT	1
23	POWER FACTOR [P.F]	16bit SIGNED INT	/100
24	COOLANT TEMPERATURE [°C]	16bit SIGNED INT	1
25	OIL PRESSURE [bar]	16bit SIGNED INT	/10
26	OIL TEMPERATURE [°C]	16bit SIGNED INT	1
27	USER TEMPERATURE [°C]	16bit SIGNED INT	1
28	FUEL LEVEL [%]	16bit SIGNED INT	1

ADDRESS	DATA	TYPE	SCALE
29	BATTERY VOLTAGE [V]	16bit SIGNED INT	/10
30	RUNNING HOUR [hour] HIGH	16bit SIGNED INT	Note1)
31	RUNNING HOUR [hour] HIGH	16bit SIGNED INT	Note1)
32	kW HOUR [kWh] HIGH	16bit SIGNED INT	Note2)
33	kW HOUR [kWh] LOW	16bit SIGNED INT	Note2)
34	kvar HOUR [kvarh] HIGH	16bit SIGNED INT	Note3)
35	kvar HOUR [kvarh] LOW	16bit SIGNED INT	Note3)
36	STATUS OF LED	16bit UNSIGNED INT	Note4)
37	CURRENT SEQUENCE	16bit UNSIGNED INT	Note4)
38	ALARM STATUS	16bit UNSIGNED INT	Note4)
39	DETAIL ALARM LIST1	16bit UNSIGNED INT	Note5)
40	DETAIL ALARM LIST2	16bit UNSIGNED INT	Note5)
41	DETAIL ALARM LIST3	16bit UNSIGNED INT	Note5)
42	DETAIL ALARM LIST4	16bit UNSIGNED INT	Note5)
43	DETAIL ALARM LIST5	16bit UNSIGNED INT	Note5)
59	USER TEMP 2 SENSOR [°C]	16bit SIGNED INT	Temp: 1 Press: /100 (Will change according to setup by user)
60	USER TEMP 1 SENSOR [bar]	16bit SIGNED INT	
61	USER TEMP 2 SENSOR [bar]	16bit SIGNED INT	
62	COOLANT LEVEL SENSOR [%]	16bit SIGNED INT	
63	COOLANT TEMP LH SENS [°C]	16bit SIGNED INT	
64	COOLANT TEMP RH SENS [°C]	16bit SIGNED INT	
65	OIL PRESS LH SENSOR [bar]	16bit SIGNED INT	
66	OIL PRESS RH SENSOR [bar]	16bit SIGNED INT	
67	EXT-MODULE SENSOR ALARM 1	16bit UNSIGNED INT	Note6)
68	EXT-MODULE SENSOR ALARM 2	16bit UNSIGNED INT	Note6)
69	ECU SENSOR ALARM	16bit UNSIGNED INT	Note7)
70	ECU COOL TEMP [°C]	16bit SIGNED INT	1
71	ECU OIL TEMP [°C]	16bit SIGNED INT	1
72	ECU OIL PRESS [kPa]	16bit SIGNED INT	1
73	ECU FUEL LEVEL [%]	16bit SIGNED INT	1
74	ECU OIL LEVEL [%]	16bit SIGNED INT	1
75	ECU COOL LEVEL [%]	16bit SIGNED INT	1
76	ECU RPM	16bit SIGNED INT	1
77	ECU BOOST PRESS [kPa]	16bit SIGNED INT	1
78	ECU INTAKE TEMP [°C]	16bit UNSIGNED INT	1
79	ECU FUEL RATE [L/hr]	16bit SIGNED INT	1

Note1) Operation Hour : {(Operation Hour [h] High X 65536) + (Operation Hour [h] Low)} / 100

Note2) kW Hour : {(kW Hour [kWh] High X 65536) + (kW Hour [kWh] Low)} / 100

Note3) kvar Hour : {(kvar Hour [kvarh] High X 65536) + (kvar Hour [kvarh] Low)} / 100

Note4) BIT FIELD

BIT	36	37	38
0	GEN ALARM	READY	RESERVED
1	BREAKER CLOSE	PRE-CRANK	WARNING
2	BREAKER OPEN	CRANK-ON	TRIP
3	GEN RUNNING	CRANK-OFF	STOP
4	-	BUILD-UP	SHUTDOWN
5	-	RUNNING	TRIP+STOP
6	-	COOLDOWN	TRIP+SHUTDOWN
7	-	STOP	-
8	BLOCK MODE	-	-
9	MANUAL MODE	-	-
10	AUTO MODE	-	-
11	MAINS ON	-	-
12	-	-	-
13	-	-	-
14	-	-	-
15	-	-	-

Note5) BIT FIELD

BIT	39	40	41	42	43
0	OVR	OSR	COOLANT TEMP HIGH	DI 1 User Fault	DI 11 Input Fault
1	UVR	USR	COOLANT TEMP LOW	DI 2 Input Fault	DI 12 Input Fault
2	OCR (INSTANT)	EMERGENCY STOP	OIL PRESS HIGH	DI 3 Input Fault	DI 13 Input Fault
3	OCR (CONSTANT)	FAIL TO START	OIL PRESS LOW	DI 4 Input Fault	DI 14 Input Fault
4	OCR (INVERSE)	FAIL TO STOP	OIL TEMP HIGH	DI 5 Input Fault	DI 15 Input Fault
5	OCGR(DI)	FAIL TO STOP(RPM)	OIL TEMP LOW	DI 6 Input Fault	DI 16 Input Fault
6	OCGR(SET)	FAIL TO STOP(OP GAUGE)	USER TEMP HIGH	DI 7 Input Fault	DI 17 Input Fault
7	OCGR(CONSTANT)	FAIL TO STOP(OP SWITCH)	USER TEMP LOW	DI 8 Input Fault	DI 18 Input Fault
8	OCGR(INVERSE)	COOLANT TEMP HIGH S/W	FUEL LEVEL HIGH	DI 9 Input Fault	-
9	OFR	OIL PRESS LOW S/W	FUEL LEVEL LOW	DI 10 Input Fault	-
10	UFR	NO CHARGING S/W	SENSOR1 FAULT	-	-
11	FAIL TO BUILD-UP	COOLANT LEVEL S/W	SENSOR2 FAULT	-	-
12	BREAKER AUX FAILURE	BAT VOLTAGE HIGH	SENSOR3 FAULT	-	-
13	-	BAT VOLTAGE LOW	SENSOR4 FAULT	-	-
14	-	MPU FAILURE	SENSOR5 FAULT	-	-
15	-	-	-	-	-

Note6) BIT FIELD

BIT	46	47	48
0	DI 01 Input	DI 11 Input (DI 01 Input of EP20-1)	DO 01 Output
1	DI 02 Input	DI 12 Input (DI 02 Input of EP20-1)	DO 02 Output
2	DI 03 Input	DI 13 Input (DI 03 Input of EP20-1)	DO 03 Output
3	DI 04 Input	DI 14 Input (DI 04 Input of EP20-1)	DO 04 Output
4	DI 05 Input	DI 15 Input (DI 05 Input of EP20-1)	DO 05 Output
5	DI 06 Input	DI 16 Input (DI 06 Input of EP20-1)	DO 06 Output
6	DI 07 Input	DI 17 Input (DI 07 Input of EP20-1)	DO 07 Output
7	DI 08 Input	DI 18 Input (DI 08 Input of EP20-1)	DO 08 Output
8	DI 09 Input	RESERVED	DO 01 Output of EP20-1
9	DI 10 Input	RESERVED	DO 02 Output of EP20-1
10	RESERVED	RESERVED	DO 03 Output of EP20-1
11	RESERVED	RESERVED	DO 04 Output of EP20-1
12	RESERVED	RESERVED	DO 05 Output of EP20-1
13	RESERVED	RESERVED	DO 06 Output of EP20-1
14	RESERVED	RESERVED	DO 07 Output of EP20-1
15	RESERVED	RESERVED	DO 08 Output of EP20-1

Note7) BIT FIELD

BIT	67	68	69
0	USER TEMP SENSOR 2 HIGH	USER TEMP 2 SENSOR FAULT	ECU COOL TEMP SENSOR
1	USER TEMP SENSOR 2 LOW	COOLANT TEMP LH SENSOR FAULT	ECU OIL PRESS SENSOR
2	COOLANT TEMP LH HIGH	COOLANT TEMP RH SENSOR FAULT	ECU OIL TEMP SENSOR
3	COOLANT TEMP LH LOW	OIL PRESS LH SENSOR FAULT	ECU BOOST PRESS SENSOR
4	COOLANT TEMP RH HIGH	OIL PRESS RH SENSOR FAULT	ECU INTAKE TEMP SENSOR
5	COOLANT TEMP RH LOW	USER PRESS 1 SENSOR FAULT	RESERVED
6	OIL PRESS LH HIGH	USER PRESS 2 SENSOR FAULT	RESERVED
7	OIL PRESS LH LOW	COOLANT LEVEL SENSOR FAULT	RESERVED
8	OIL PRESS RH HIGH	COOLANT TEMP LH SWITCH	RESERVED
9	OIL PRESS RH LOW	COOLANT TEMP RH SWITCH	RESERVED
10	USER PRESS 1 HIGH	OIL PRESS LH SWITCH	RESERVED
11	USER PRESS 1 LOW	OIL PRESS RH SWITCH	RESERVED
12	USER PRESS 2 HIGH	EXT-MODULE COMM FAULT	RESERVED
13	USER PRESS 2 LOW	ECU COMM FAULT	RESERVED
14	COOLANT LEVEL HIGH	ECU OIL PRESS SWITCH FAULT	RESERVED
15	COOLANT LEVEL LOW	ECU COOLANT TEMP HIGH S/W FAULT	RESERVED

18.1.2. CONTROL (05h)

ADDRESS	DATA	VALUE
0001	STOP	0xFF00
0002	START	
0003	RESET	
0005	MODE	
0006	BLOCK	
0007	MANUAL	
0008	AUTO	
0009	CLOSE	
0010	OPEN	

Note) Gen-set STOP, START, breaker CLOSE and breaker OPEN works only in MANUAL mode.

18.1.3. Communication example

Request		Response	
DATA(h)	Description	DATA(h)	Description
02	Address	02	Address
04	Function	04	Function
00	Starting address Hi	14	Byte count
00	Starting address Lo-1	00	Data Hi
00	Num of registers Hi	00	Data Low
0A	Num of registers Lo	-	
XX	CRC	XX	CRC
XX		XX	

18.2. GIMAC-II Plus PROTOCOL

Items	Setup
Protocol Type	MODBUS RTU
Communication Configuration	RS485 Half Duplex
Device ID Setup	0 ~ 255
Baud Rate Setup	9600, 19200, 38400 [bps]
Parity Setup	Even, Odd, None
Data Bit	8 [bit]
Stop Bit	1 [bit]
Support Function Code	Request(04h) only
Support Exception Code	Illegal Function(01h), Illegal Address(02h), Illegal Data Value(03h)
Frame-End Silent Interval	Firmware under V2.66 : 50[ms], Firmware over V2.67 : 5[ms]
Support Address	30001 ~ 30035

18.2.1. REQUEST (04h)

ADDRESS	DATA	TYPE	SCALE
01	DI status	16Bit UNSIGNED INT	Note6)
02	DO status	16Bit UNSIGNED INT	Note6)
03	Device status	16Bit UNSIGNED INT	Note6)
04	Reserved	16Bit UNSIGNED INT	
05	Gen U current [A]	32Bit FLOAT	
07	Gen V current [A]	32Bit FLOAT	
09	Gen W current [A]	32Bit FLOAT	
11	Gen U-N voltage [V] (Phase voltage)	32Bit FLOAT	
13	Gen V-N voltage [V] (Phase voltage)	32Bit FLOAT	
15	Gen W-N voltage [V] (Phase voltage)	32Bit FLOAT	
17	Gen U-V voltage [V] (Line voltage)	32Bit FLOAT	
19	Gen V-W voltage [V] (Line voltage)	32Bit FLOAT	
21	Gen W-U voltage [V] (Line voltage)	32Bit FLOAT	
23	Power factor [P.F]	32Bit FLOAT	
25	Active power [kW]	32Bit FLOAT	
27	Reactive power [kvar]	32Bit FLOAT	
29	Apparent power [kVA]	32Bit FLOAT	
31	Frequency [Hz]	32Bit FLOAT	
33	kW Hour [kWh]	32Bit FLOAT	
35	kvar Hour [kvarh]	32Bit FLOAT	

Note6) BIT FIELD

BIT	01	02	03
0	OVR	Gen-set start	-
1	UVR	Auto Mode	-
2	OCR	-	-
3	OCGR	-	-
4	OSR	Breaker open Output	-
5	Coolant Temp High	Breaker close output	-
6	Oil Press Low	Breaker open contact input	-
7	Fail to Start, Fail to Stop	Breaker close contact input	-
8	DI 3 Input Alarm	DO 1 Output	Sys Error - Breaker aux alarm, Low battery voltage
9	DI 4 Input Alarm	DO 2 Output	Alarm - Setup when alarm occurs
10	DI 5 Input Alarm	DO 3 Output	Event - Not use
11	DI 6 Input Alarm	DO 4 Output	-
12	DI 7 Input Alarm	DO 5 Output	Remote / Local - Not use
13	DI 8 Input Alarm	DO 6 Output	-
14	DI 9 Input Alarm	DO 7 Output	-
15	DI 10 Input Alarm	DO 8 Output	Setup when using SWAP SET - WORD SWAP

18.2.2. CONTROL (05h)

ADDRESS	DATA	VALUE
0002	BREAKER CLOSE	0xFF00
0004	BREAKER OPEN	
0006	START	
0010	STOP	
0014	BREAKER CLOSE	
0018	BREAKER OPEN	
0022	BLOCK MODE	
0026	MANUAL MODE	
0030	AUTO MODE	
0034	ALARM RELEASE	

19. Inverse Characteristics Curve

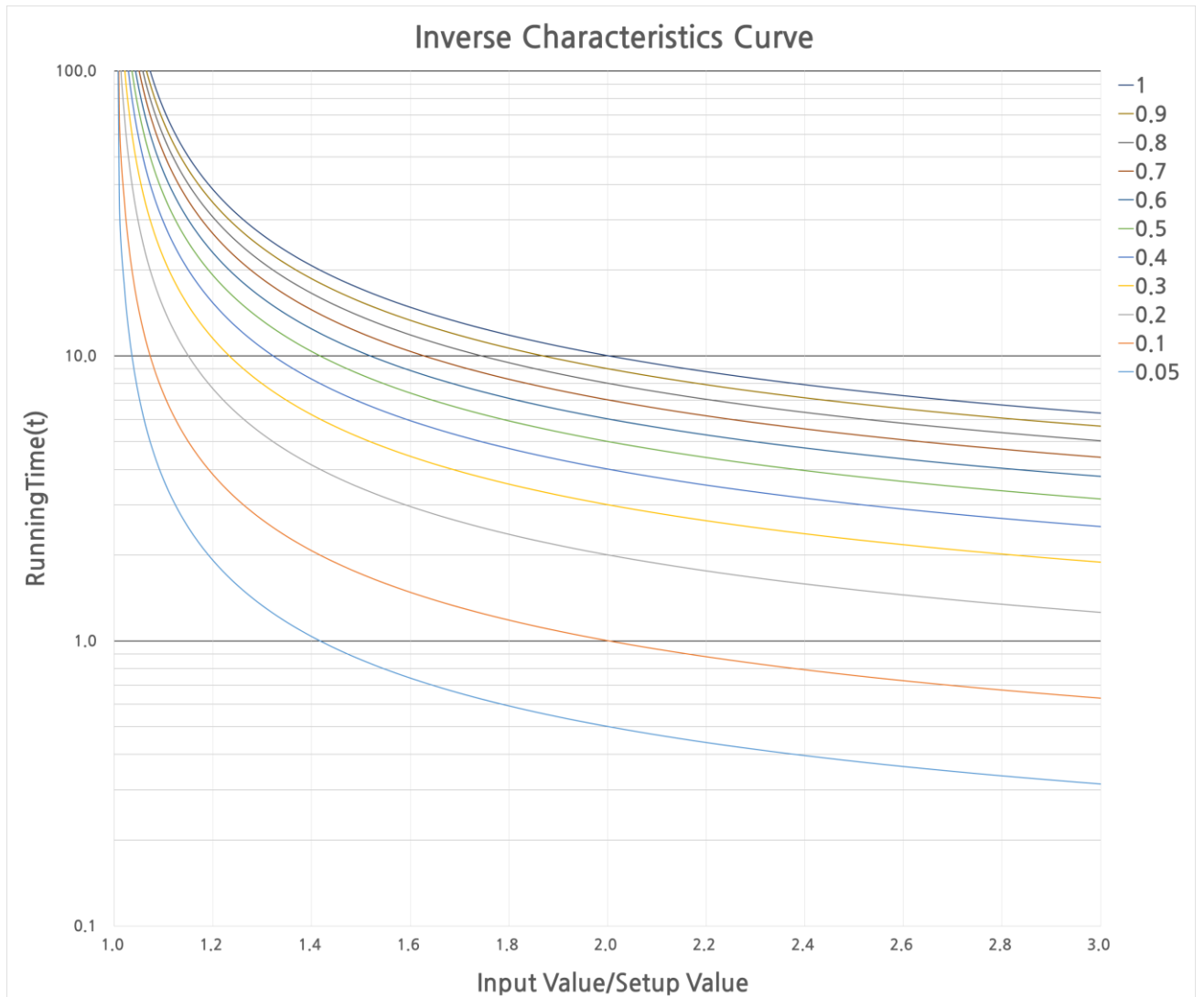

- Applicable range : OVR, OCR, OCGR
- X axis : Input value / Setup value
- Y axis : Running time(s)
- Lever setup value : 0.05~1.00
- Equation for trip time,

$$Inverse\ Time(s) = \frac{0.14}{(Input\ Value/ Set\ Value)^{0.02} - 1} \times Lever$$